

9 January 2013

Agreement

Concerning the Adoption of Uniform Technical Prescriptions for Wheeled Vehicles, Equipment and Parts which can be fitted and/or be used on Wheeled Vehicles and the Conditions for Reciprocal Recognition of Approvals Granted on the Basis of these Prescriptions*

(Revision 2, including the amendments which entered into force on 16 October 1995)

Addendum 111: Regulation No. 112

Revision 3

Incorporating all valid text up to:

01 series of amendments to the Regulation – Date of entry into force: 9 December 2010

Corrigendum 1 to the 01 series of amendments to the Regulation – Date of entry into force: 9 March 2011

Supplement 1 to the 01 series of amendments to the Regulation – Date of entry into force: 28 October 2011

Supplement 2 to the 01 series of amendments to the Regulation – Date of entry into force: 26 July 2012

Supplement 3 to the 01 series of amendments to the Regulation – Date of entry into force: 18 November 2012

Uniform provisions concerning the approval of motor vehicle headlamps emitting an asymmetrical passing-beam or a driving-beam or both and equipped with filament lamps and/or light-emitting diode (LED) modules



UNITED NATIONS

* Former title of the Agreement: Agreement concerning the adoption of uniform conditions of approval and reciprocal recognition of approval for motor vehicle equipment and parts, done at Geneva on 20 March 1958.

Regulation No. 112

Uniform provisions concerning the approval of motor vehicle headlamps emitting an asymmetrical passing-beam or a driving-beam or both and equipped with filament lamps and/or light-emitting diode (LED) modules

Contents

	<i>Page</i>
A. Administrative provisions	
Scope	5
1. Definitions	5
2. Application for approval of a headlamp	6
3. Markings	7
4. Approval	8
B. Technical requirements for headlamps	
5. General specifications	11
6. Illumination	14
7. Colour	21
8. Gauging of discomfort	21
C. Further administrative provisions	
9. Modification of the headlamp type and extension of approval	22
10. Conformity of production	22
11. Penalties for non-conformity of production	23
12. Production definitively discontinued	23
13. Names and addresses of Technical Services responsible for conducting approval tests and of Type Approval Authorities	23
14. Transitional provisions	23
Annexes	
1. Communication.....	25
2. Examples of arrangement of approval marks	27
3. Spherical coordinate measuring system and test point locations	33
4. Tests for stability of photometric performance of headlamps in operation.....	35
Appendix 1 - Overview of operational periods concerning test for stability of photometric performance.....	41
5. Minimum requirements for conformity of production control procedures	42

6	Requirements for lamps incorporating lenses of plastic material - Testing of lens or material samples and of complete lamps	45
	Appendix 1 - Chronological order of approval tests	51
	Appendix 2 - Method of measurement of the diffusion and transmission of light.....	53
	Appendix 3 - Spray testing method	55
	Appendix 4 - Adhesive tape adherence test	56
7	Minimum requirements for sampling by an inspector	57
8	Overview of operational periods concerning tests for stability of photometric performance	63
9	Instrumental verification of the "cut-off" for passing-beam headlamps	65
10	Requirements for LED modules and headlamps including LED modules	69
11	A general illustration for principal passing-beam and beam contributors and correlated light source options	73

A. Administrative provisions

Scope¹

This Regulation applies to headlamps for vehicles of categories L, M, N and T².

1. Definitions

For the purpose of this Regulation,

- 1.1. "*Lens*" means the outermost component of the headlamp (unit) which transmits light through the illuminating surface;
- 1.2. "*Coating*" means any product or products applied in one or more layers to the outer face of a lens;
- 1.3. Headlamps of different "*types*" mean headlamps which differ in such essential respects as:
 - 1.3.1. The trade name or mark;
 - 1.3.2. The characteristics of the optical system;
 - 1.3.3. The inclusion or elimination of components capable of altering the optical effects by reflection, refraction, absorption and/or deformation during operation;
 - 1.3.4. Suitability for right-hand or left-hand traffic or for both traffic systems;
 - 1.3.5. The kind of beam produced (passing-beam, driving-beam or both);
 - 1.3.6. The materials constituting the lenses and coating, if any;
 - 1.3.7. The category of filament lamp used and/or the LED module specific identification code(s).
 - 1.3.8. However, a device intended for the installation on the left side of the vehicle and the corresponding device intended for the installation on the right side of the vehicle shall be considered to be of the same type.
- 1.4. Headlamps of different "*Classes*" (A or B) mean headlamps identified by particular photometric provisions.
- 1.5. The definitions given in Regulation No. 48 and its series of amendments in force at the time of application for type approval shall apply to this Regulation.
- 1.6. References made in this Regulation to standard (étalon) filament lamp(s) and to Regulation No. 37 shall refer to Regulation No. 37 and its series of amendments in force at the time of application for type approval.

¹ Nothing in this Regulation shall prevent a Party to the Agreement applying this Regulation from prohibiting the combination of a headlamp incorporating a lens of plastic material approved under this Regulation with a mechanical headlamp-cleaning device (with wipers).

² As defined in the Consolidated Resolution on the Construction of Vehicles (R.E.3.), document ECE/TRANS/WP.29/78/Rev.2, para. 2.

2. Application for approval of a headlamp

- 2.1. The application for approval shall be submitted by the owner of the trade name or mark or by his duly accredited representative. It shall specify:
 - 2.1.1. Whether the headlamp is intended to provide both a passing-beam and a driving-beam or only one of these beams;
 - 2.1.2. Whether, if the headlamp is intended to provide a passing-beam, it is designed for both left-hand and right-hand traffic or for either left-hand or right-hand traffic only;
 - 2.1.3. If the headlamp is equipped with an adjustable reflector, the mounting position(s) of the headlamp in relation to the ground and the longitudinal median plane of the vehicle;
 - 2.1.4. Whether it concerns a Class A or B headlamp;
 - 2.1.5. The category of the filament lamp(s) used, as listed in Regulation No. 37 and its series of amendments in force at the time of application for type approval, and/or the light source module specific identification code(s) for LED modules, if available.
- 2.2. Every application for approval shall be accompanied by:
 - 2.2.1. Drawings in triplicate in sufficient detail to permit identification of the type and representing a frontal view of the headlamp, with details of lens ribbing if any, and the cross section. The drawings shall indicate the space(s) reserved for the approval mark and in case of LED module(s) also the space reserved for the specific identification code(s) of the module(s);
 - 2.2.1.1. If the headlamp is equipped with an adjustable reflector, an indication of the mounting position(s) of the headlamp in relation to the ground and the longitudinal median plane of the vehicle, if the headlamp is for use in that (those) position(s) only;
 - 2.2.2. A brief technical description including, in the case where headlamps are used to produce bend lighting, the extreme positions according to paragraph 6.2.7. below. In the case of LED module(s) this shall include:
 - (a) A brief technical specification of the LED module(s);
 - (b) A drawing with dimensions and the basic electrical and photometric values and the objective luminous flux and for each LED module a statement whether it is replaceable or not;
 - (c) In case of electronic light source control gear, information on the electrical interface necessary for approval testing;
 - 2.2.3. Two samples of each type of headlamp, one sample intended for the installation on the left side of the vehicle and one sample intended for the installation of the right side of the vehicle.
 - 2.2.4. For the test of plastic material of which the lenses are made:
 - 2.2.4.1. Fourteen lenses;
 - 2.2.4.1.1. Ten of these lenses may be replaced by ten samples of material at least 60 x 80 mm in size, having a flat or convex outer surface and a substantially flat area (radius of curvature not less than 300 mm) in the middle measuring at least 15 x 15 mm;

- 2.2.4.1.2. Every such lens or sample of material shall be produced by the method to be used in mass production;
- 2.2.4.2. A reflector to which the lenses can be fitted in accordance with the manufacturer's instructions.
- 2.2.5. For testing the ultraviolet (UV)-resistance of light transmitting components made of plastic material against UV radiation of LED modules inside the headlamp:
 - 2.2.5.1. One sample of each of the relevant material as being used in the headlamp or one headlamp sample containing these. Each material sample shall have the same appearance and surface treatment, if any, as intended for use in the headlamp to be approved;
 - 2.2.5.2. The UV-resistance testing of internal materials to light source radiation is not necessary if no LED modules other than low-UV-types as specified in Annex 10 of this Regulation are being applied or if provisions are taken, to shield the relevant headlamp components from UV radiation, e.g. by glass filters.
- 2.2.6. One electronic light source control gear, if applicable.
- 2.3. The materials making up the lenses and coatings, if any, shall be accompanied by the test report of the characteristics of these materials and coatings if they have already been tested.

3. Markings

- 3.1. Headlamps submitted for approval shall bear the trade name or mark of the applicant.
- 3.2. They shall comprise, on the lens and on the main body³, spaces of sufficient size for the approval mark and the additional symbols referred to in paragraph 4; these spaces shall be indicated on the drawings referred to in paragraph 2.2.1. above.
- 3.3. Headlamps equipped with passing-beam designed to satisfy the requirements both of right-hand and of left-hand traffic shall bear markings indicating the two settings of the optical unit or LED module on the vehicle or of the filament lamp on the reflector; these markings shall consist of the letters "R/D" for the position for right-hand traffic and the letters "L/G" for the position for left-hand traffic.
- 3.4. In the case of lamps with LED module(s), the lamp shall bear the marking of the rated voltage and rated wattage and the light source module specific identification code.
- 3.5. LED module(s) submitted along with the approval of the lamp:
 - 3.5.1. Shall bear the trade name or mark of the applicant. This marking shall be clearly legible and indelible;

³ If the lens cannot be detached from the main body of the headlamp, a unique marking as per paragraph 4.2.5. shall be sufficient.

- 3.5.2. Shall bear the specific identification code of the module. This marking shall be clearly legible and indelible.

This specific identification code shall comprise the starting letters "MD" for "MODULE" followed by the approval marking without the circle as prescribed in paragraph 4.2.1. below and in the case several non-identical light source modules are used, followed by additional symbols or characters. This specific identification code shall be shown in the drawings mentioned in paragraph 2.2.1. above. The approval marking does not have to be the same as the one on the lamp in which the module is used, but both markings shall be from the same applicant.

- 3.6. If an electronic light source control gear which is not part of a LED module is used to operate a LED module(s), it shall be marked with its specific identification code(s), the rated input voltage and wattage.

4. Approval

4.1. General

- 4.1.1. If all the samples of a type of headlamp submitted pursuant to paragraph 2. above satisfy the provisions of this Regulation, approval shall be granted.

- 4.1.2. Where grouped, combined or reciprocally incorporated lamps satisfy the requirements of more than one Regulation, a single international approval mark may be affixed provided that each of the grouped, combined or reciprocally incorporated lamps satisfies the provisions applicable to it.

- 4.1.3. An approval number shall be assigned to each type approved. Its first two digits shall indicate the series of amendments incorporating the most recent major technical amendments made to the Regulation at the time of issue of the approval. The same Contracting Party may not assign the same number to another type of headlamp covered by this Regulation.

- 4.1.4. Notice of approval or of extension or refusal or withdrawal of approval or production definitely discontinued of a type of headlamp pursuant to this Regulation shall be communicated to the Parties to the 1958 Agreement applying this Regulation, by means of a form conforming to the model in Annex 1 to this Regulation, with the indications according to paragraph 2.2.1.1.

- 4.1.4.1. If the headlamp is equipped with an adjustable reflector and if this headlamp is to be used only in mounting positions according to the indications in paragraph 2.2.1.1. the applicant shall be obliged by the Type Approval Authority to inform the user in a proper way about the correct mounting position(s).

- 4.1.5. In addition to the mark prescribed in paragraph 3.1., an approval mark as described in paragraphs 4.2. and 4.3. below shall be affixed in the spaces referred to in paragraph 3.2. above to every headlamp conforming to a type approved under this Regulation.

4.2. Composition of the approval mark

The approval mark shall consist of:

- 4.2.1. An international approval mark, comprising:

- 4.2.1.1. A circle surrounding the letter "E" followed by the distinguishing number of the country which has granted approval⁴;
- 4.2.1.2. The approval number prescribed in paragraph 4.1.3. above;
- 4.2.2. The following additional symbol (or symbols):
- 4.2.2.1. On headlamps meeting left-hand traffic requirements only, a horizontal arrow pointing to the right of an observer facing the headlamp, i.e. to the side of the road on which the traffic moves;
- 4.2.2.2. On headlamps designed to meet the requirements of both traffic systems by means of an appropriate adjustment of the setting of the optical unit or the filament lamp or LED module(s), a horizontal arrow with a head on each end, the heads pointing respectively to the left and to the right;
- 4.2.2.3. On headlamps meeting the requirements of this Regulation in respect of the passing-beam only, the letters "C" for Class A headlamp or "HC" for Class B headlamp;
- 4.2.2.4. On headlamps meeting the requirements of this Regulation in respect of the driving-beam only, the letters "R" for Class A headlamp or "HR" for Class B headlamp;
- 4.2.2.5. On headlamps meeting the requirements of this Regulation in respect of both the passing-beam and the driving-beam, the letters "CR" for Class A headlamp or "HCR" for Class B headlamp;
- 4.2.2.6. On headlamps incorporating a lens of plastic material, the group of letters "PL" to be affixed near the symbols prescribed in paragraphs 4.2.2.3. to 4.2.2.5. above;
- 4.2.2.7. On headlamps meeting the requirements of this Regulation in respect of the driving-beam, an indication of the maximum luminous intensity expressed by a reference mark, as defined in paragraph 6.3.4. below, placed near the circle surrounding the letter "E";
- In the case of grouped or reciprocally incorporated driving-beam headlamps, indication of the maximum luminous intensity of the driving-beams as a whole shall be expressed as above.
- 4.2.3. In every case the relevant operating mode used during the test procedure according to paragraph 1.1.1.1. of Annex 4 and the permitted voltage(s) according to paragraph 1.1.1.2. of Annex 4 shall be stipulated on the approval forms and on the communication forms transmitted to the countries which are Contracting Parties to the Agreement and which apply this Regulation.
- In the corresponding cases the device shall be marked as follows:
- 4.2.3.1. On headlamps meeting the requirements of this Regulation which are so designed that the filament or LED module(s) producing the principal passing-beam shall not be lit simultaneously with that of any other lighting function with which it may be reciprocally incorporated: an oblique stroke (/) shall be placed behind the symbol indicating the headlamp producing the passing-beam in the approval mark.

⁴ The distinguish numbers of the Contracting Parties to the 1958 Agreement are reproduced in Annex 3 to the Consolidated Resolution on the Construction of Vehicles (R.E.3), document ECE/TRANS/WP.29/78/Rev.2/Amend.1.

- 4.2.3.2. On headlamps equipped with filament lamps and meeting the requirements of Annex 4 to this Regulation only when supplied with a voltage of 6 V or 12 V, a symbol consisting of the number 24 crossed out by an oblique cross (x), shall be placed near the filament lamp holder.
- 4.2.4. The two digits of the approval number which indicate the series of amendments incorporating the most recent major technical amendments made to the Regulation at the time of issue of the approval and, if necessary, the required arrow may be marked close to the above additional symbols.
- 4.2.5. The marks and symbols referred to in paragraphs 4.2.1. to 4.2.3. above shall be clearly legible and be indelible. They may be placed on an inner or outer part (transparent or not) of the headlamp, which cannot be separated from the transparent part of the headlamp emitting the light. In any case they shall be visible when the headlamp is fitted on the vehicle or when a movable part such as the hood is opened.
- 4.3. Arrangement of the approval mark
- 4.3.1. Independent lamps
- Figures 1 to 10 of Annex 2 to this Regulation give examples of arrangements of the approval mark with the above-mentioned additional symbols.
- 4.3.2. Grouped, combined or reciprocally incorporated lamps
- 4.3.2.1. Where grouped, combined or reciprocally incorporated lamps have been found to comply with the requirements of several Regulations, a single international approval mark may be affixed, consisting of a circle surrounding the letter "E" followed by the distinguishing number of the country which has granted the approval, and an approval number. This approval mark may be located anywhere on the grouped, combined or reciprocally incorporated lamps, provided that:
- 4.3.2.1.1. It is visible as per paragraph 4.2.5.;
- 4.3.2.1.2. No part of the grouped, combined or reciprocally incorporated lamps that transmits light can be removed without at the same time removing the approval mark.
- 4.3.2.2. The identification symbol for each lamp appropriate to each Regulation under which approval has been granted, together with the corresponding series of amendments incorporating the most recent major technical amendments to the Regulation at the time of issue of the approval, and if necessary, the required arrow shall be marked:
- 4.3.2.2.1. Either on the appropriate light-emitting surface,
- 4.3.2.2.2. Or in a group, in such a way that each of the grouped, combined or reciprocally incorporated lamps may be clearly identified (see four possible examples in Annex 2).
- 4.3.2.3. The size of the components of a single approval mark shall not be less than the minimum size required for the smallest of the individual marks by the Regulation under which approval has been granted.
- 4.3.2.4. An approval number shall be assigned to each type approved. The same Contracting Party may not assign the same number to another type of grouped, combined or reciprocally incorporated lamps covered by this Regulation.

- 4.3.2.5. Figure 11 of Annex 2 to this Regulation gives examples of arrangements of approval marks for grouped, combined or reciprocally incorporated lamps with all the above-mentioned additional symbols.
- 4.3.3. Lamps, the lens of which are used for different types of headlamps and which may be reciprocally incorporated or grouped with other lamps
- The provisions laid down in paragraph 4.3.2. above are applicable.
- 4.3.3.1. In addition, where the same lens is used, the latter may bear the different approval marks relating to the different types of headlamps or units of lamps, provided that the main body of the headlamp, even if it cannot be separated from the lens, also comprises the space described in paragraph 3.2. above and bears the approval marks of the actual functions.
- If different types of headlamps comprise the same main body, the latter may bear the different approval marks.
- 4.3.3.2. Figure 12 of Annex 2 to this Regulation gives examples of arrangements of approval marks relating to the above case.

B. Technical requirements for headlamps⁵

5. General specifications

- 5.1. Each sample shall conform to the specifications set forth in paragraphs 6. to 8. below.
- 5.2. Headlamps shall be so made as to retain their prescribed photometric characteristics and to remain in good working order when in normal use, in spite of the vibrations to which they may be subjected.
- 5.2.1. Headlamps shall be fitted with a device enabling them to be so adjusted on the vehicles as to comply with the rules applicable to them. Such a device need not be fitted on units in which the reflector and the diffusing lens cannot be separated, provided the use of such units is confined to vehicles on which the headlamp setting can be adjusted by other means.
- Where a headlamp providing a principal passing-beam and a headlamp providing a driving-beam, each equipped with its own filament lamp or LED module(s), the adjusting device shall enable the principal passing-beam and the driving-beam to be adjusted individually.
- 5.2.2. However, these provisions shall not apply to headlamp assemblies whose reflectors are indivisible. For this type of assembly the requirements of paragraph 6.3. of this Regulation apply.
- 5.3. The headlamp shall be equipped with:
- 5.3.1. Filament lamp(s) approved according to Regulation No. 37. Any filament lamp covered by Regulation No. 37 may be used, provided that no restriction on the use is made in Regulation No. 37 and its series of amendments in force at the time of application for type approval.

⁵ Technical requirements for filament lamps: see Regulation No. 37.

- 5.3.1.1. The design of the device shall be such that the filament lamp can be fixed in no other position but the correct one⁶;
- 5.3.1.2. The filament lamp holder shall conform to the characteristics given in IEC Publication 60061. The holder data sheet relevant to the category of filament lamp used, applies.
- 5.3.2. And/or LED module(s):
 - 5.3.2.1. Electronic light source control gear(s), if applicable, shall be considered to be part of the headlamp; they may be part of the LED module(s);
 - 5.3.2.2. The headlamp, if equipped with LED modules, and the LED module(s) themselves shall comply with the relevant requirements specified in Annex 10 to this Regulation. The compliance with the requirements shall be tested.
 - 5.3.2.3. The total objective luminous flux of all LED modules producing the principal passing-beam and measured as described in paragraph 5. of Annex 10 shall be equal or greater than 1,000 lumens.
 - 5.3.2.4. In the case of a replaceable LED module the removal and replacement of this LED module, as described in Annex 10, paragraph 1.4.1. shall be demonstrated to the satisfaction of the Technical Service.
- 5.4. Headlamps designed to satisfy the requirements both of right hand and of left hand traffic may be adapted for traffic on a given side of the road either by an appropriate initial setting when fitted on the vehicle or by selective setting by the user. Such initial or selective setting may consist, for example, of fixing either the optical unit at a given angle on the vehicle or the filament lamp or LED module(s) producing the principal passing-beam at a given angle/position in relation to the optical unit. In all cases, only two different and clearly distinct settings, one for right hand and one for left-hand traffic, shall be possible, and the design shall preclude inadvertent shifting from one setting to the other or setting in an intermediate position. Where two different setting positions are provided for the filament lamp or LED module(s) producing the principal passing-beam, the components for attaching the filament lamp or LED module(s) producing the principal passing-beam to the reflector must be so designed and made that, in each of its two settings, this filament lamp or LED module(s) will be held in position with the precision required for headlamps designed for traffic on only one side of the road. Conformity with the requirements of this paragraph shall be verified by visual inspection and, where necessary, by a test fitting.
- 5.5. Complementary tests shall be done according to the requirements of Annex 4 to ensure that in use there is no excessive change in photometric performance.
- 5.6. Light transmitting components made of plastic material shall be tested according to the requirements of Annex 6.

⁶ A headlamp is regarded as satisfying the requirements of this paragraph if the filament lamp can be easily fitted into the headlamp and the positioning lugs can be correctly fitted into their slots even in darkness.

- 5.7. On headlamps designed to provide alternately a driving-beam and a passing-beam, or a passing-beam and/or a driving-beam designed to become bend lighting, any mechanical, electromechanical or other device incorporated in the headlamp for these purposes shall be so constructed that:
- 5.7.1. The device is robust enough to withstand 50,000 operations under normal conditions of use. In order to verify compliance with this requirement, the Technical Service responsible for approval tests may:
- (a) Require the applicant to supply the equipment necessary to perform the test;
 - (b) Forego the test if the headlamp presented by the applicant is accompanied by a test report, issued by a Technical Service responsible for approval tests for headlamps of the same construction (assembly), confirming compliance with this requirement.
- 5.7.2. In the case of failure, the luminous intensity above the line H-H shall not exceed the values of a passing-beam according to paragraph 6.2.4.; in addition, on headlamps designed to provide a passing and/or a driving-beam to become a bend lighting, a minimum luminous intensity of at least 2,500 cd. shall be fulfilled in test point 25 V (VV line, 1.72D).
- When performing the tests to verify compliance with these requirements, the Technical Service responsible for approval tests shall refer to the instructions supplied by the applicant.
- 5.7.3. Either the principal passing-beam or the driving-beam shall always be obtained without any possibility of the mechanism stopping in between two positions;
- 5.7.4. The user cannot, with ordinary tools, change the shape or position of the moving parts.
- 5.8. Illumination configuration for different traffic conditions
- 5.8.1. In the case of headlamps designed to meet the requirements of traffic moving on one side of the road (either right or left) only, appropriate measures shall be taken to prevent discomfort to road-users in a country where traffic moves on the side of the road opposite to that of the country for which the headlamp was designed⁷. Such measures may be:
- (a) Occulting a part of the outer headlamp lens area;
 - (b) Downward movement of the beam. Horizontal movement is allowed;
 - (c) Any other measure to remove or reduce the asymmetrical part of the beam.
- 5.8.2. Following the application of this (these) measure(s) the following requirements regarding the luminous intensity of the headlamp shall be met with the adjustment left unchanged compared to that for the original traffic direction:

⁷ Instructions on the installation of lamps fitted with the measures are given in Regulation No. 48.

- 5.8.2.1. Passing-beam designed for right-hand traffic and adapted to left-hand traffic:
 - at 0.86D-1.72L at least 2,500 cd;
 - at 0.57U-3.43R not more than 880 cd.
- 5.8.2.2. Passing-beam designed for left-hand traffic and adapted to right-hand traffic:
 - at 0.86D-1.72R at least 2,500 cd;
 - at 0.57U-3.43L not more than 880 cd.
- 5.9. In case of a passing-beam headlamp incorporating a light source or LED module(s) producing the principal passing-beam and having a total objective luminous flux which exceeds 2,000 lumens, a reference shall be made in item 9. of the communication form in Annex 1. The objective luminous flux of LED modules shall be measured as described in paragraph 5. of Annex 10.
- 5.10. The definitions in paragraphs 2.7.1.1.3. and 2.7.1.1.7. in Regulation No. 48 allow the use of LED modules, which may contain holders for other light sources. Notwithstanding this provision a mixture of LED'(s) and other light sources for the principal dipped beam or the contributor to the bend lighting or each driving-beam, as specified by this Regulation is not allowed.
- 5.11. A LED module shall be:
 - (a) Only removable from its device with the use of tools, unless it is stated in the communication sheet that the LED module is non-replaceable, and
 - (b) So designed that regardless of the use of tool(s), it is not mechanically interchangeable with any replaceable approved light source.

6. Illumination

- 6.1. General provisions
 - 6.1.1. Headlamps shall be so made that they give adequate illumination without dazzle when emitting the passing-beam, and good illumination when emitting the driving-beam. Bend lighting may be produced by activating one additional filament light source or one or more LED module(s) being part of the passing-beam headlamp.
 - 6.1.2. The luminous intensity produced by the headlamp shall be measured at 25 m distance by means of a photoelectric cell having a useful area comprised within a square of 65 mm side. The point HV is the centre-point of the coordinate system with a vertical polar axis. Line h is the horizontal through HV (see Annex 3 to this Regulation).
 - 6.1.3. Apart from LED module(s), the headlamps shall be checked by means of an uncoloured standard (étalon) filament lamp designed for a rated voltage of 12 V.
 - 6.1.3.1. During the checking of the headlamp, the voltage at the terminals of the filament lamp shall be regulated as to obtain the reference luminous flux at 13.2 V as indicated for each filament lamp at the relevant data sheet of Regulation No. 37.

However, if a filament lamp of category H9 or H9B is used for the principal passing-beam, the applicant may choose the reference luminous flux at 12.2 V or 13.2 V as indicated in the relevant data sheet of Regulation No. 37 and a reference stating which voltage was chosen for type approval shall be made in item 9 in the communication form of Annex 1.

- 6.1.3.2. In order to protect the standard (étalon) filament lamp during the process of photometric measurement it is permissible to carry out the measurements at a luminous flux that differs from the reference luminous flux at 13.2 V. If the Technical Service chooses to carry out measurements in such a manner, the luminous intensity shall be corrected by multiplying the measured value by the individual factor F_{lamp} of the standard (étalon) filament lamp in order to verify the compliance with the photometric requirements where:

$$F_{\text{lamp}} = \Phi_{\text{reference}} / \Phi_{\text{test}}$$

$\Phi_{\text{reference}}$ is the reference luminous flux at 13,2 V as specified in the relevant data sheet of Regulation No. 37

Φ_{test} is the actual luminous flux used for the measurement.

However, where the reference luminous flux of 12.2 V as specified in the data sheet for the category H9 or H9B is chosen, this procedure is not permitted.

- 6.1.3.3. The headlamp shall be considered acceptable if it meets the requirements of paragraph 6. with at least one standard (étalon) filament lamp, which may be submitted with the headlamp.
- 6.1.4. LED module(s) shall be measured at 6.3 V, 13.2 V or 28.0 V respectively, if not otherwise specified within this Regulation. LED module(s) operated by an electronic light source control gear, shall be measured as specified by the applicant.
- 6.1.5. In the case of headlamps equipped with LED module(s) and filament lamps, the part of the headlamp with filament lamp(s) shall be tested according to paragraph 6.1.3. and the part of the headlamp with LED module(s) shall be evaluated according to the provisions of paragraph 6.1.4. and then added to the previous result obtained from the filament lamp(s) tested.

6.2. Provisions concerning passing-beams

- 6.2.1. The luminous intensity distribution of the principal passing-beam headlamp shall incorporate a "cut-off" (see Figure 1), which enables the headlamp to be adjusted correctly for the photometric measurements and for the aiming on the vehicle.

The "cut-off" shall provide:

- (a) For right hand traffic beams:
- (i) A straight "horizontal part" towards the left;
 - (ii) A raised "elbow – shoulder" part towards the right.
- (b) For left hand traffic beams:
- (i) A straight "horizontal part" towards the right;
 - (ii) A raised "elbow - shoulder" part towards the left.

In each case the "elbow-shoulder" part shall have a sharp edge.

- 6.2.2. The headlamp shall be visually aimed by means of the "cut-off" (see Figure 1) as follows. The aiming shall be carried out using a flat vertical screen set up at a distance of 10 m or 25 m (as indicated in item 9 of Annex 1) forward of the headlamp and at right angles to the H-V axis as shown in Annex 3 to this Regulation. The screen shall be sufficiently wide to allow examination and adjustment of the "cut-off" of the passing-beam over at least 5° on either side of the V-V line.
- 6.2.2.1. For vertical adjustment: the horizontal part of the "cut-off" is moved upward from below line B and adjusted to its nominal position one per cent (0.57 degrees) below the H-H line;

Figure 1

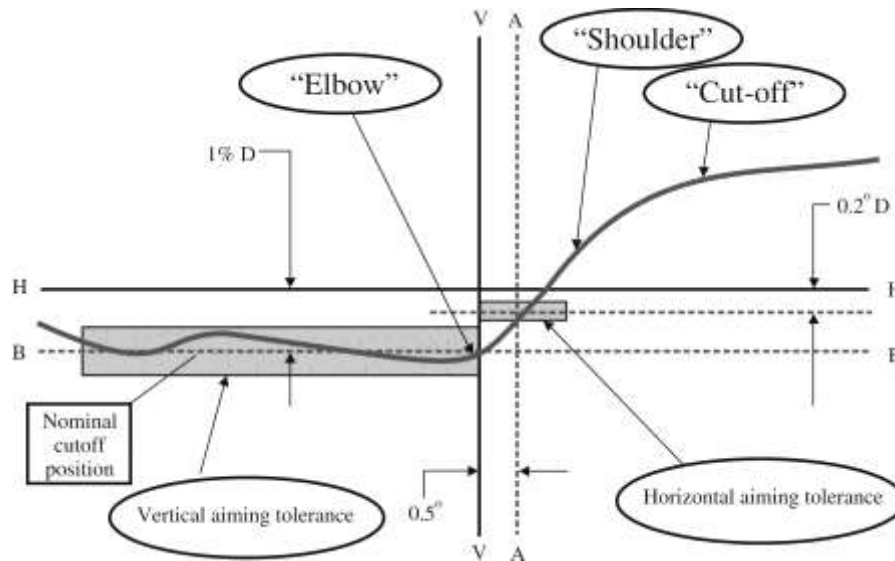

Note: The scales are different for vertical and horizontal lines.

- 6.2.2.2. For horizontal adjustment: the "elbow – shoulder" part of the "cut-off" shall be moved:
- For right hand traffic from right to left and shall be horizontally positioned after its movement so that:
- Above the line $0.2^\circ D$ its "shoulder" shall not exceed the line A to the left;
 - The line $0.2^\circ D$ or below its "shoulder" should cross the line A; and
 - The kink of the "elbow" is basically located within ± 0.5 degrees to the left or right of the V-V line;
- or
- For left hand traffic from left to right and shall be horizontally positioned after its movement so that:
- Above the line $0.2 D$ its "shoulder" shall not exceed the line A to the right;
 - On the line 0.2° or below its "shoulder" cross the line A; and
 - The kink of the "elbow" should be primarily on the V-V line;

- 6.2.2.3. Where a headlamp so aimed does not meet the requirements set out in paragraphs 6.2.4. to 6.2.6. and 6.3., its alignment may be changed, provided that the axis of the beam is not displaced:
- Horizontally from line A by more than:
- (a) 0.5° to the left or 0.75° to the right, for right hand traffic; or
 - (b) 0.5° to the right or 0.75° to the left, for left hand traffic; and
- Vertically not more than 0.25° up or down from line B.
- 6.2.2.4. If, however, vertical adjustment cannot be performed repeatedly to the required position within the tolerances described in paragraph 6.2.2.3. above, the instrumental method of Annex 9, paragraphs 2. and 3. shall be applied to test compliance with the required minimum quality of the "cut-off" and to perform the vertical and horizontal adjustment of the beam.
- 6.2.3. When so aimed, the headlamp, if its approval is sought solely for provision of a passing-beam⁸, need comply only with the requirements set out in paragraphs 6.2.4. to 6.2.6. below; if it is intended to provide both a passing-beam and a driving-beam, it shall comply with the requirements set out in paragraphs 6.2.4. to 6.2.6. and 6.3.
- 6.2.4. The passing-beam shall meet the luminous intensities at the test points referred to in the tables below and in Annex 3 Figure B (or mirrored about the VV line for left-hand traffic):

⁸ Such a special "passing-beam" headlamp may incorporate a driving-beam not subject to requirements.

<i>Headlamps for RH Traffic**</i>							<i>Class A Headlamp</i>		<i>Class B Headlamp</i>	
<i>Test point designation</i>			<i>Test point angular coordinates - Degrees</i>				<i>Required luminous intensity cd</i>		<i>Required luminous intensity cd</i>	
							<i>Max</i>	<i>Min</i>	<i>Max</i>	<i>Min</i>
B 50 L			0.57U, 3.43L				350		350	
BR			1.0 U, 2.5R				1,750		1,750	
75 R			0.57D, 1.15R					5,100		10,100
75 L			0.57D, 3.43L				10,600		10,600	
50 L			0.86D, 3.43L				13,200***		13,200***	
50 R			0.86D, 1.72R					5,100		10,100
50 V			0.86D, 0							5,100
25 L			1.72D, 9.0L					1,250		1,700
25 R			1.72D, 9.0R					1,250		1,700
Any point in zone III (bounded by the following coordinates in degrees)							625		625	
8 L	8 L	8 R	8 R	6 R	1.5 R	V-V				
1 U	4 U	4 U	2 U	1.5 U	1.5 U	H-H				
Any point in zone IV (0.86D to 1.72D, 5.15 L to 5.15 R)								1,700		2,500
Any point in zone I (1.72D to 4D, 9 L to 9 R)							17,600		< 2I*	

Note: In the table:

Letter L means that the point is located on the left of VV line.

Letter R means that the point is located on the right of VV line.

Letter U means the point is located above HH line

Letter D means the point or segment is located below HH line

* Actual measured value at points 50R / 50L respectively

** For left-hand traffic, the letter R shall be replaced by letter L and vice versa.

*** In case where a headlamp in which LED modules are producing a passing-beam in conjunction with an electronic light source control gear, the measured value shall not be more than 18,500 cd.

<i>Headlamps for RH Traffic**</i>		
<i>Test point</i>	<i>Angular coordinates Degrees</i>	<i>Required luminous intensity- cd Min</i>
1	4U, 8L	Points 1+2+3 190
2	4U, 0	
3	4U, 8R	
4	2U, 4L	Points 4+5+6 375
5	2U, 0	
6	2U, 4R	
7	0, 8L	65
8	0, 4L	125

- 6.2.5. There shall be no lateral variations detrimental to good visibility in any of the zones I, II, III and IV.
- 6.2.6. Headlamps designed to meet the requirements of both right-hand and left-hand traffic must, in each of the two setting positions of the optical unit or LED module(s) producing the principal passing-beam or of the filament lamp, meet the requirements set forth above for the corresponding direction of traffic.
- 6.2.7. The requirements in paragraph 6.2.4. above shall also apply to headlamps designed to provide bend lighting and/or that include the additional light source or LED module(s) referred to in paragraph 6.2.8.2. In the case of a headlamp designed to provide bend lighting its alignment may be changed, provided that the axis of the beam is not displaced vertically by more than 0.2°.
- 6.2.7.1. If bend lighting is obtained by:
- 6.2.7.1.1. Swivelling the passing-beam or moving horizontally the kink of the elbow of the cut-off, the measurements shall be carried out after the complete headlamp assembly has been reaimed horizontally, e.g. by means of a goniometer;
- 6.2.7.1.2. Moving one or more optical parts of the headlamp without moving horizontally the kink of the elbow of the cut-off, measurements shall be carried out with these parts being in their extreme operating position;
- 6.2.7.1.3. Means of one additional filament light source or one or more LED module(s) without moving horizontally the kink of the elbow of the cut-off, measurements shall be carried out with this light source or LED module(s) activated.
- 6.2.8. Only one filament light source or one or more LED module(s) are permitted for the principal passing-beam. Additional light sources or LED modules are permitted only as follows (see Annex 10):

- 6.2.8.1. One additional light source according to Regulation No. 37 or one or more additional LED module(s) may be used inside the passing-beam headlamp to contribute to bend lighting;
- 6.2.8.2. One additional light source according to Regulation No. 37 and/or one or more LED module(s), inside the passing-beam headlamp, may be used for the purposes of generating infrared radiation. It/they shall only be activated at the same time as the principal light source or LED module(s). In the event that the principal light source or (one of) the principal LED module(s) fails, this additional light source and/or LED module(s) shall be automatically switched off;
- 6.2.8.3. In the event of failure of an additional filament light source or one or more additional LED module(s), the headlamp shall continue to fulfil the requirements of the passing-beam.
- 6.3. Provisions concerning driving-beams
- 6.3.1. In the case of a headlamp designed to provide a driving-beam and a passing-beam, measurements of the luminous intensity of the driving-beam shall be taken with the same headlamp alignment as for measurements under paragraphs 6.2.4. to 6.2.6. above; in the case of a headlamp providing a driving-beam only, it shall be so adjusted that the area of maximum luminous intensity is centred on the point of intersection of lines H-H and V-V; such a headlamp need meet only the requirements referred to in paragraph 6.3. Where more than one light source is used to provide the driving-beam, the combined functions shall be used to determine the maximum value of the luminous intensity (I_M).
- 6.3.2. Irrespective of the type of light source (LED module(s) or filament light source(s)) used to produce the principal passing-beam, several light sources:
- (a) Either filament light sources listed in Regulation No. 37; or
 - (b) LED module(s) may be used for each individual driving-beam.
- 6.3.3. Referring to Annex 3, Figure C and the table below, the luminous intensity distribution of the driving-beam shall meet the following requirements:

		<i>Class A Headlamp</i>	<i>Class B Headlamp</i>
<i>Test point</i>	<i>Angular coordinates - Degrees</i>	<i>Required luminous intensity cd</i>	<i>Required luminous intensity cd</i>
		<i>Min</i>	<i>Min</i>
I_{max}		27,000	40,500
H-5L	0.0, 5.0 L	3,400	5,100
H-2.5L	0.0, 2.5 L	13,500	20,300
H-2.5R	0.0, 2.5 R	13,500	20,300
H-5R	0.0, 5.0 R	3,400	5,100

- 6.3.3.1. The point of intersection (HV) of lines h h and v v shall be situated within the isolux 80 per cent of maximum luminous intensity (I_{\max})
- 6.3.3.2. The maximum value (I_M) shall in no circumstances exceed 215,000 cd.
- 6.3.4. The reference mark (I'_M) of the maximum luminous intensity, referred to in paragraph 6.3.3.2. above, shall be obtained by the ratio:

$$I'_M = I_M / 4,300$$

This value shall be rounded off to the value 7.5 - 10 - 12.5 - 17.5 - 20 - 25 - 27.5 - 30 - 37.5 - 40 - 45 - 50.

- 6.4. In the case of headlamps with adjustable reflector the requirements of paragraphs 6.2. and 6.3. are applicable for each mounting position indicated according to paragraph 2.1.3. For verification the following procedure shall be used:
- 6.4.1. Each applied position is realized on the test goniometer with respect to a line joining the centre of the light source and point HV on a aiming screen. The adjustable reflector is then moved into such a position that the light pattern on the screen corresponds to the aiming prescriptions of paragraphs 6.2.1. to 6.2.2.3. and/or 6.3.1.;
- 6.4.2. With the reflector initially fixed according to paragraph 6.4.1., the headlamp must meet the relevant photometric requirements of paragraphs 6.2. and 6.3.;
- 6.4.3. Additional tests are made after the reflector has been moved vertically $\pm 2^\circ$ or at least into the maximum position, if less than 2° , from its initial position by means of the headlamps adjusting device. Having re-aimed the headlamp as a whole (by means of the goniometer for example) in the corresponding opposite direction the light output in the following directions shall be controlled and lie within the required limits:
- passing-beam : points HV and 75 R (75 L respectively);
driving-beam : I_M and point HV (percentage of I_M).
- 6.4.4. If the applicant has not indicated more than one mounting position, the procedure of paragraphs 6.4.1. to 6.4.3. shall be repeated for all other positions;
- 6.4.5. If the applicant has not asked for special mounting positions, the headlamp shall be aimed for measurements of paragraphs 6.2. and 6.3. with the headlamps adjusting device in its mean position. The additional test of paragraph 6.4.3. shall be made with the reflector moved into its extreme positions (instead of $\pm 2^\circ$) by means of the headlamps adjusting device.

7. Colour

- 7.1. The colour of the light emitted shall be white.

8. Gauging of discomfort

The discomfort caused by the passing-beam of headlamps shall be gauged⁹.

⁹ This requirement will be the subject of a recommendation to administrations.

C. Further administrative provisions

9. Modification of the headlamp type and extension of approval

- 9.1. Every modification of the headlamp type shall be notified to the Type Approval Authority which approved the headlamp type. The said Authority may then either:
- 9.1.1. Consider that the modifications made are unlikely to have appreciable adverse effects and that in any event the headlamp still complies with the requirements; or
- 9.1.2. Require a further test report from the Technical Service responsible for conducting the tests.
- 9.2. Confirmation or refusal of approval, specifying the alterations, shall be communicated by the procedure specified in paragraph 4.1.4. above to the Parties to the Agreement which apply this Regulation.
- 9.3. The competent Authority issuing the extension of approval shall assign a series number to each communication form drawn up for such an extension and inform thereof the other Parties to the 1958 Agreement applying this Regulation by means of a communication form conforming to the model in Annex 1 to this Regulation.

10. Conformity of production

The conformity of production procedures shall comply with those set out in the Agreement, Appendix 2 (E/ECE/324-E/ECE/TRANS/505/Rev.2) with the following requirements:

- 10.1. Headlamps approved under this Regulation shall be so manufactured as to conform to the type approved by meeting the requirements set forth in paragraphs 6. and 7.
- 10.2. The minimum requirements for conformity of production control procedures set forth in Annex 5 to this Regulation shall be complied with.
- 10.3. The minimum requirements for sampling by an inspector set forth in Annex 7 to this Regulation shall be complied with.
- 10.4. The authority which has granted type approval may at any time verify the conformity control methods applied in each production facility. The normal frequency of these verifications shall be once every two years.
- 10.5. Headlamps with apparent defects are disregarded.
- 10.6. The reference mark is disregarded.
- 10.7. The measuring points 1 to 8 from paragraph 6.2.4. of this Regulation are disregarded.

11. Penalties for non-conformity of production

- 11.1. The approval granted in respect of a type of headlamp pursuant to this Regulation may be withdrawn if the requirements are not complied with or if a headlamp bearing the approval mark does not conform to the type approved.
- 11.2. If a Contracting Party to the Agreement applying this Regulation withdraws an approval it has previously granted, it shall forthwith so notify the other Contracting Parties applying this Regulation by means of a communication form conforming to the model in Annex 1 to this Regulation.

12. Production definitively discontinued

If the holder of the approval completely ceases to manufacture a type of headlamp approved in accordance with this Regulation, he shall so inform the authority which granted the approval. Upon receiving the relevant communication, that authority shall inform thereof the other Parties to the 1958 Agreement applying this Regulation by means of a communication form conforming to the model in Annex 1 to this Regulation.

13. Names and addresses of Technical Services responsible for conducting approval tests and of Type Approval Authorities

The Parties to the 1958 Agreement applying this Regulation shall communicate to the United Nations Secretariat the names and addresses of the Technical Services responsible for conducting approval tests and of the Type Approval Authorities which grant approval and to which forms certifying approval or extension or refusal or withdrawal of approval, or production definitively discontinued, issued in other countries, are to be sent.

14. Transitional provisions

- 14.1. From the date of entry into force of the 01 series of amendments to this Regulation, no Contracting Party applying it shall refuse to grant approvals under this Regulation as amended by the 01 series of amendments.
- 14.2. Until 60 months after the date of entry into force of the 01 series of amendments to this Regulation with regard to the changes introduced by the 01 series of amendments concerning the photometric testing procedures involving the use of the spherical coordinate system and the specification of luminous intensity values, and in order to allow the Technical Services to update their testing equipment, no Contracting Party applying this Regulation shall refuse to grant approvals under this Regulation as amended by the 01 series of amendments where existing testing equipment is used with suitable conversion of the values, to the satisfaction of the authority responsible for type approval.
- 14.3. As from 60 months after the date of entry into force of the 01 series of amendments, Contracting Parties applying this Regulation shall grant approvals only if the headlamp meets the requirements of this Regulation as amended by the 01 series of amendments.

- 14.4. Existing approvals for headlamps already granted under this Regulation before the date of entry into force of the 01 series of amendments shall remain valid indefinitely.
- 14.5. Contracting Parties applying this Regulation shall not refuse to grant extensions of approvals to the preceding series to this Regulation.

Annex 1

Communication

(maximum format: A4 (210 x 297 mm))

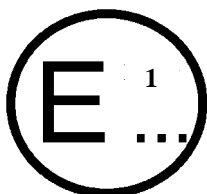

issued by: Name of administration:

.....
.....
.....

concerning²: Approval granted
Approval extended
Approval refused
Approval withdrawn
Production definitively discontinued

of a type of headlamp pursuant to Regulation No. 112

Approval No Extension No

1. Trade name or mark of the device:
2. Manufacturer's name for the type of device:
3. Manufacturer's name and address:
4. If applicable, name and address of manufacturer's representative:
.....
5. Submitted for approval on:
6. Technical Service responsible for conducting approval tests:
.....
7. Date of report issued by that Service:
8. Number of report issued by that Service:

¹ Distinguishing number of the country which has granted/refused/withdrawn approval (see the provisions of the Regulation concerning approval).

² Strike out which does not apply.

9. Brief description:
 - Category as described by the relevant marking³:
 -
 - Number and category(s) of filament lamp(s):
 -
 - Reference luminous flux used for the principal passing-beam (lm):.....
 - Principal passing-beam operated at approximately (V):
 - Measures according to paragraph 5.8. of this Regulation:
 - Number and specific identification code(s) of LED module(s) and for each LED module a statement whether it is replaceable or not: yes/no²
 - Number and specific identification code(s) of electronic light source control gear(s)..
 -
 - Total objective luminous flux as described in paragraph 5.9. exceeds 2,000 lumens: yes/no/does not apply²
 - The adjustment of the cut-off has been determined at: 10 m/25 m/does not apply²
 - The determination of the minimum sharpness of the "cut-off" has been carried out at: 10 m/25 m/does not apply²
10. Approval mark position:
11. Reason(s) for extension of approval:
12. Approval granted/extended/refused//withdrawn²
13. Place:
14. Date:
15. Signature:
16. The list of documents deposited with the Type Approval Authority which has granted approval is annexed to this communication and may be obtained on request.

³ Indicate the appropriate marking selected from the list below:

C, C, C, R, R PL, CR, CR, CR, C/R, C/R, C/R, C/, C/, C/,
 → ↔
 C, PL, C PL, C PL, CR PL, CR PL, CR PL, C/R PL, C/R PL, C/R PL,
 → ↔
 C/PL, C/PL, C/PL
 → ↔
 HC, HC, HC, HR, HR PL, HCR, HCR, HCR, HC/R, HC/R, HC/R, HC/, HC/, HC/
 → ↔
 HC PL, HC PL, HC PL, HCR PL, HCR PL, HCR PL, HC/R PL, HC/R PL, HC/R PL,
 → ↔
 HC/PL, HC/PL, HC/PL
 → ↔

Annex 2

Examples of arrangement of approval marks

Figure 1

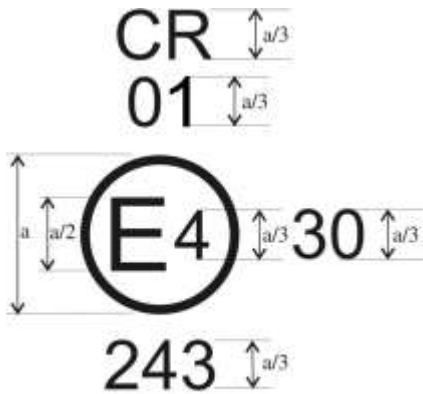
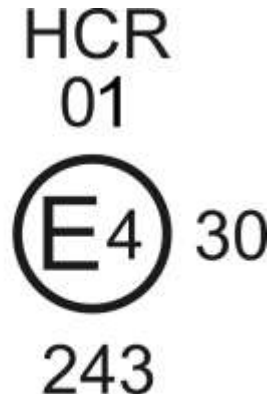

Figure 2



$a \geq 8 \text{ mm}$

The headlamp bearing one of the above approval marks has been approved in the Netherlands (E4) pursuant to Regulation No. 112 under approval number 243, meeting the requirements of this Regulation, as amended by the 01 series of amendments. The passing-beam is designed for right-hand traffic only. The letters CR (Figure 1) indicate that it concerns a Class A passing and driving-beam and the letters HCR (Figure 2) indicate that it concerns a Class B passing and driving-beam.

The figure 30 indicates that the maximum luminous intensity of the driving-beam is between 123,625 and 145,125 candelas.

Note: The approval number and additional symbols shall be placed close to the circle and either above or below the letter "E", or to the right or left of that letter. The digits of the approval number shall be on the same side of the letter "E" and face in the same direction.

The use of Roman numerals as approval numbers should be avoided so as to prevent any confusion with other symbols.

Figure 3

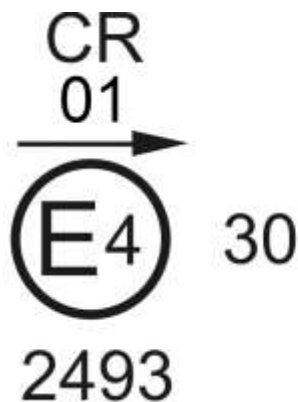

Figure 4a

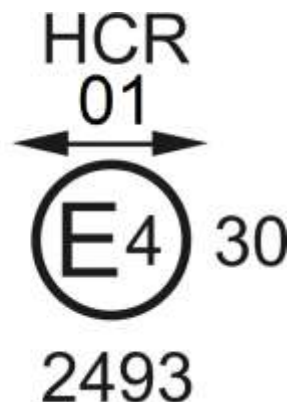

Figure 4b



The headlamp bearing the above approval mark meets the requirements of this Regulation in respect of both the passing-beam and the driving-beam and is designed:

Figure 3: Class A for left hand traffic only.

Figures 4a and 4b: Class B for both traffic systems by means of an appropriate adjustment of the setting of the optical unit or the filament lamp on the vehicle.

Figure 5



Figure 6



The headlamp bearing the above approval mark is a headlamp incorporating a lens of plastic material meeting the requirements of this Regulation in respect of the passing-beam only and is designed:

Figure 5: Class A for both traffic systems.

Figure 6: Class B for right-hand traffic only.

Figure 7



Figure 8



The headlamp bearing the above approval mark is a headlamp meeting the requirements of this Regulation:

Figure 7: Class B in respect of the passing-beam only and is designed for left-hand traffic only.

Figure 8: Class A in respect of the driving-beam only.

Figure 9

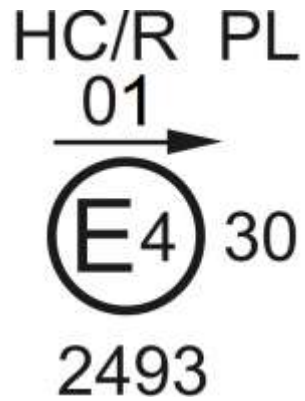

Figure 10



Identification of a headlamp incorporating a lens of plastic material meeting the requirements of this Regulation:

Figure 9: Class B in respect to both the passing-beam and driving-beam and designed for right-hand traffic only.

Figure 10: Class B in respect to the passing-beam only and designed for right-hand traffic only.

The passing-beam shall not be operated simultaneously with the driving-beam and/or another reciprocally incorporated headlamp.

Figure 11

Simplified marking for grouped, combined or reciprocally incorporated lamps

(The vertical and horizontal lines schematize the shape of the light-signalling device. They are not part of the approval mark).

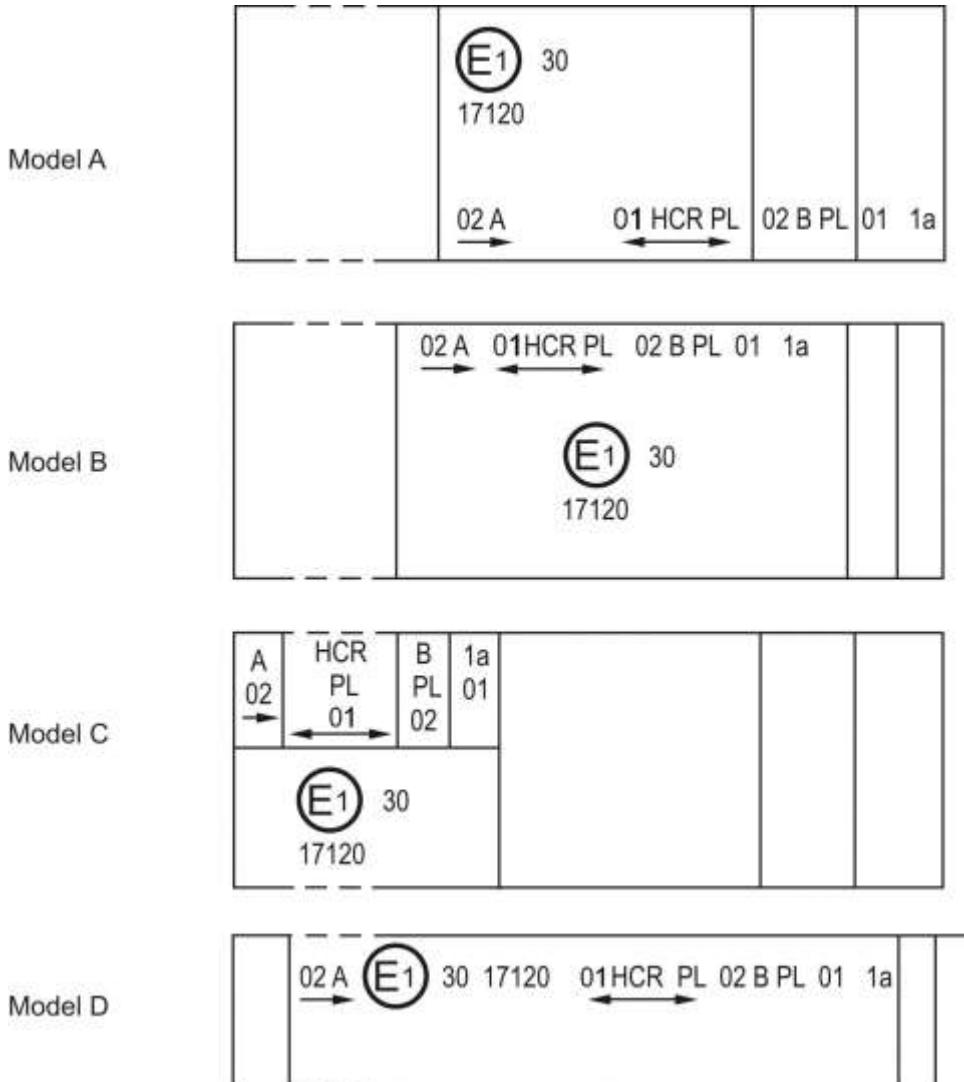

Note: The four examples above correspond to a lighting device bearing an approval mark comprising:

A *front position lamp* approved in accordance with the 02 series of amendments to Regulation No. 7,

A *headlamp*, Class B, with a passing-beam designed for right- and left-hand traffic and a driving-beam with a maximum intensity comprised between 123,625 and 145,125 candelas (as indicated by the number 30), approved in accordance with the requirements of this Regulation, as amended by the 01 series of amendments and incorporating a lens of plastic material,

A *front fog lamp* approved in accordance with the 02 series of amendments to Regulation No. 19 and incorporating a lens of plastic material,

A *front direction indicator lamp* of category 1a approved in accordance with the 01 series of amendments to Regulation No. 6.

Figure 12
Lamp reciprocally incorporated with a headlamp

Example 1

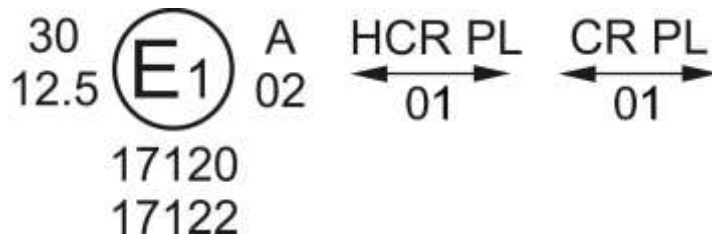

The above example corresponds to the marking of a lens of plastic material intended to be used in different types of headlamps, namely:

Either A headlamp, Class B, with a passing-beam designed for both traffic systems and a driving-beam with a maximum luminous intensity comprised between 123,625 and 145,125 candelas (as indicated by the number 30), approved in Germany (E1) in accordance with the requirements of this Regulation, as amended by the 01 series of amendments,

Which is reciprocally incorporated with

A front position lamp approved in accordance with the 02 series of amendments to Regulation No. 7;

or A headlamp, Class A, with a passing-beam designed for both traffic systems and a driving-beam with a maximum luminous intensity comprised between 48,375 cd and 64,500 cd (as indicated by the number 12.5), approved in Germany (E1) in accordance with the requirements of this Regulation, as amended by the 01 series of amendments,

Which is reciprocally incorporated with:

The same front position lamp as above;

or Even either of the above-mentioned headlamps approved as a single lamp.

The main body of the headlamp shall bear the only valid approval number, for instance:

Example 2

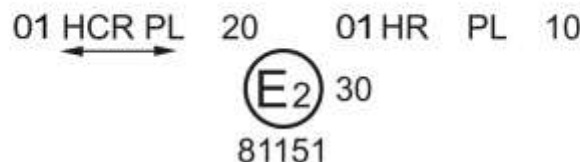
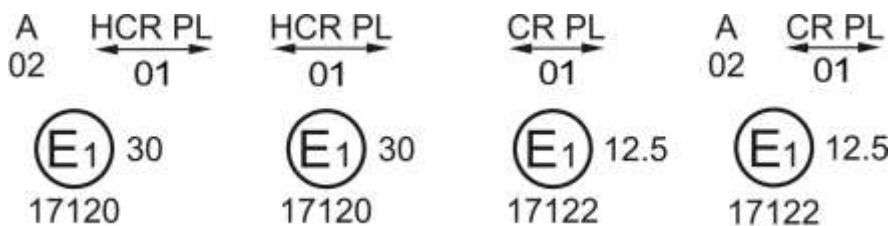

The above example corresponds to the marking of a lens of plastic material used in a unit of two headlamps approved in France (E2) under approval number 81151, consisting of:

A headlamp, Class B, emitting a passing-beam and a driving-beam with a maximum luminous intensity between x and y candelas, meeting the requirements of this Regulation, and

A headlamp, Class B, emitting a driving-beam designed for both traffic systems with a maximum luminous intensity between w and z candelas, meeting the requirements of this Regulation, the maximum luminous intensities of the driving-beams as a whole being comprised between 123,625 and 145,125 candelas.

Figure 13

LED modules

MD E3 17325

The LED module bearing the light source module identification code shown above has been approved together with a headlamp initially approved in Italy (E3) under approval number 17325.

Annex 3

Spherical coordinate measuring system and test point locations

Figure A
 Spherical coordinate measuring system

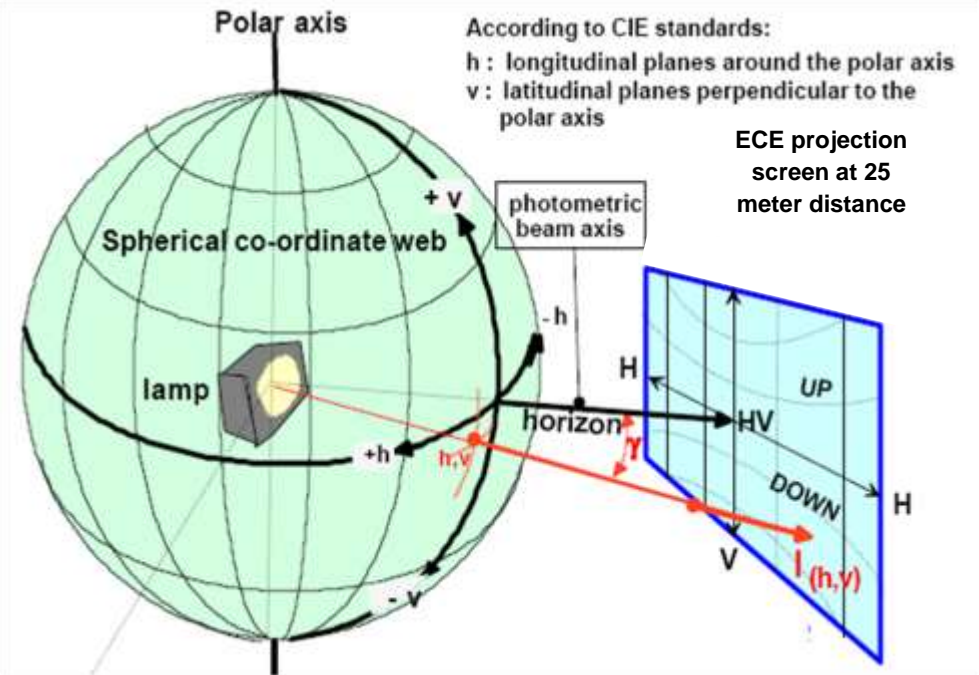

$$E_{25m} = I_{(h, \gamma)} \times \cos \gamma / r^2$$

Figure B
 Passing-beam for right-hand traffic

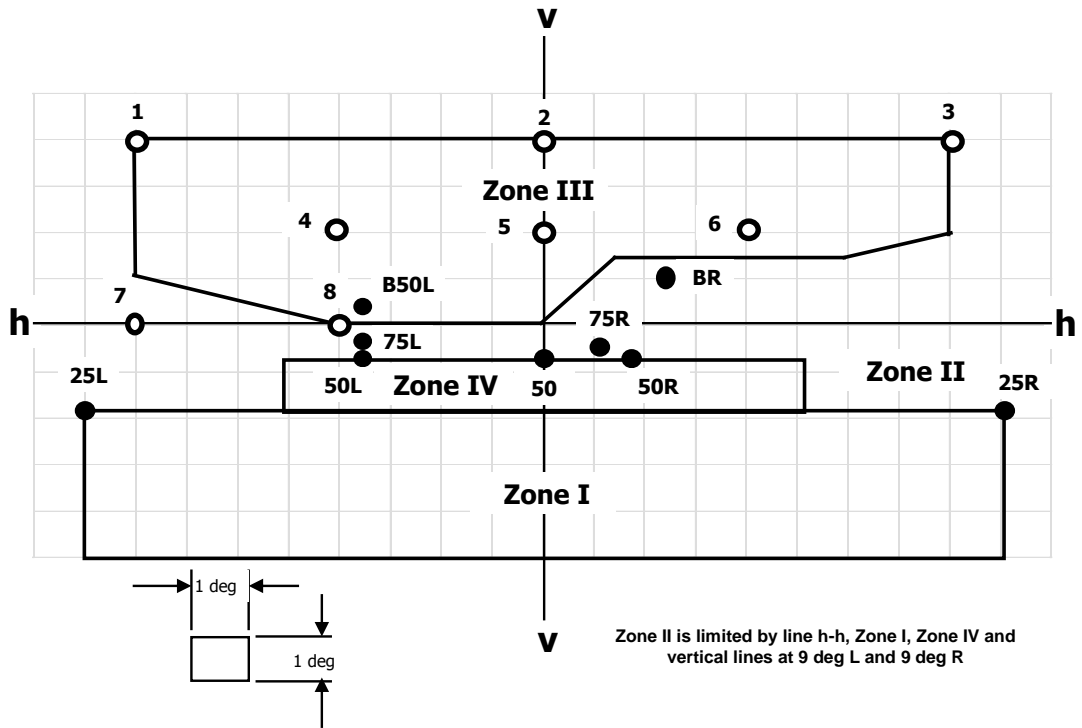

h-h = horizontal plane , v-v = vertical plane passing through the optical axis of the headlamp

The test point locations for left-hand traffic are mirrored about the VV line

Figure C
 Driving-beam test points

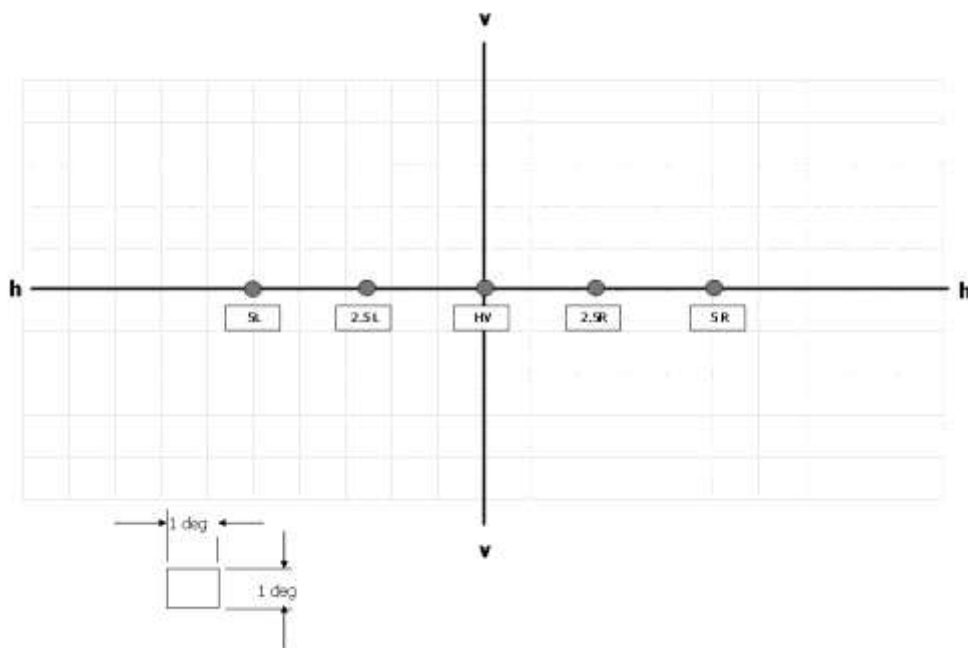

Annex 4

Tests for stability of photometric performance of headlamps in operation

Tests on complete headlamps

Once the photometric values have been measured according to the prescriptions of this Regulation, in the point for I_{\max} for driving-beam and in points HV, 50 R, B 50 L for passing-beam (or HV, 50 L, B 50 R for headlamps designed for left-hand traffic) a complete headlamp sample shall be tested for stability of photometric performance in operation. "Complete headlamp" shall be understood to mean the complete lamp itself including those surrounding body parts and lamps which could influence its thermal dissipation.

The tests shall be carried out:

- (a) In a dry and still atmosphere at an ambient temperature of $23\text{ °C} \pm 5\text{ °C}$, the test sample being mounted on a base representing the correct installation on the vehicle;
- (b) In case of replaceable light sources: using mass production filament light sources, which have been aged for at least one hour, or mass production gas-discharge light sources, which have been aged for at least 15 hours or mass production LED modules which have been aged for at least 48 hours and cooled down to ambient temperature before starting the tests as specified in this Regulation. The LED modules supplied by the applicant shall be used.

The measuring equipment shall be equivalent to that used during headlamp type approval tests.

The test sample shall be operated without being dismantled from or readjusted in relation to its test fixture. The light source used shall be a light source of the category specified for that headlamp.

1. Test for stability of photometric performance
 - 1.1. Clean headlamp

The headlamp shall be operated for 12 hours as described in paragraph 1.1.1. and checked as prescribed in paragraph 1.1.2.
 - 1.1.1. Test procedure¹

The headlamp shall be operated for a period according to the specified time, so that:

¹ For the test schedule see Annex 8 to this Regulation.

- 1.1.1.1.
- (a) In the case where only one lighting function (driving or passing-beam or front fog lamp) is to be approved, the corresponding filament and/or LED module(s) is (are) lit for the prescribed time²;
 - (b) In the case of a headlamp with a passing-beam and one or more driving-beams or in the case of a headlamp with a passing-beam and a front fog lamp:
 - (i) The headlamp shall be subjected to the following cycle until the time specified is reached:

15 minutes, principal passing-beam filament or principal passing-beam LED module(s) lit;

5 minutes, all filaments and/or LED module(s) lit.
 - (ii) If the applicant declares that the headlamp is to be used with only the passing-beam lit or only the driving-beam(s) lit³ at a time, the test shall be carried out in accordance with this condition, activating² successively the passing-beam half of the time and the driving-beam(s) (simultaneously) for half the time specified in paragraph 1.1. above.
 - (c) In the case of a headlamp with a front fog lamp and one or more driving-beams:
 - (i) The headlamp shall be subjected to the following cycle until the time specified is reached:

15 minutes, front fog lamp lit;

5 minutes, all filaments and/or all LED modules lit.
 - (ii) If the applicant declares that the headlamp is to be used with only the front fog lamp lit or only the driving-beam(s) lit³ at a time, the test shall be carried out in accordance with this condition, activating² successively the front fog lamp half of the time and the driving-beam(s) (simultaneously) for half the time specified in paragraph 1.1. above.
 - (d) In the case of a headlamp with a passing-beam, one or more driving-beams and a front fog lamp:
 - (i) The headlamp shall be subjected to the following cycle until the time specified is reached:

15 minutes, principal passing-beam filament or principal passing-beam LED module(s) lit;

5 minutes, all filaments and/or all LED modules lit.

² When the tested headlamp includes signalling lamps, the latter shall be lit for the duration of the test, except for a daytime running lamp. In the case of a direction indicator lamp, it shall be lit in flashing mode with an on/ off time of approximately one to one.

³ Should two or more lamp filaments and/or LED module(s) be simultaneously lit when headlamp flashing is used, this shall not be considered as being normal use of the filaments and/or LED module(s).

- (ii) If the applicant declares that the headlamp is to be used with only the passing-beam lit or only the driving-beam(s)³ lit at a time, the test shall be carried out in accordance with this condition, activating² successively the principal passing-beam half of the time and the driving-beam(s) for half the time specified in paragraph 1.1. above, while the front fog lamp is subjected to a cycle of 15 minutes off and 5 minutes lit for half of the time and during the operation of the driving-beam;
- (iii) If the applicant declares that the headlamp is to be used with only the passing-beam lit or only the front fog lamp³ lit at a time, the test shall be carried out in accordance with this condition, activating² successively the principal passing-beam half of the time and the front fog lamp for half of the time specified in paragraph 1.1. above, while the driving-beam(s) is(are) subjected to a cycle of 15 minutes off and 5 minutes lit for half of the time and during the operation of the principal passing-beam;
- (iv) If the applicant declares that the headlamp is to be used with only the passing-beam lit or only the driving-beam(s)³ lit or only the front fog lamp³ lit at a time, the test shall be carried out in accordance with this condition, activating² successively the principal passing-beam one third of the time, the driving-beam(s) one third of the time and the front fog lamp for one third of the time specified in paragraph 1.1. above.
- (e) In the case of a passing-beam designed to provide bend lighting with the addition of a filament light source and/or one or more LED module(s), this light source and/or LED module(s) shall be switched on for one minute, and switched off for nine minutes during the activation of the passing-beam only (see Annex 4 – Appendix 1).

1.1.1.2. Test voltage

The voltage shall be applied to the terminals of the test sample as follows:

- (a) In case of replaceable filament light source(s) operated directly under vehicle voltage system conditions:

The test shall be performed at 6.3 V, 13.2 V or 28.0 V as applicable except if the applicant specifies that the test sample may be used at a different voltage. In this case, the test shall be carried out with the filament light source operated at the highest voltage that can be used.
- (b) In case of replaceable gas discharge light source(s): The test voltage for the electronic light source control-gear is 13.2 ± 0.1 volts for 12 V vehicle voltage system, or otherwise specified in the application for approval.
- (c) In the case of non-replaceable light source operated directly under vehicle voltage system conditions: All measurements on lighting units equipped with non-replaceable light sources (filament light sources and/ or others) shall be made at 6.3 V, 13.2 V or 28.0 V or at other voltages according to the vehicle voltage system as specified by the applicant respectively.

- (d) In the case of light sources, replaceable or non-replaceable, being operated independently from vehicle supply voltage and fully controlled by the system, or, in the case of light sources supplied by a supply and operating device, the test voltages as specified above shall be applied to the input terminals of that device. The test laboratory may require from the manufacturer the supply and operating device or a special power supply needed to supply the light source(s).
- (e) LED module(s) shall be measured at 6.75 V, 13.2 V or 28.0 V respectively, if not otherwise specified within this Regulation. LED module(s) operated by an electronic light source control gear, shall be measured as specified by the applicant.
- (f) Where signalling lamps are grouped, combined or reciprocally incorporated into the test sample and operating at voltages other than the nominal rated voltages of 6 V, 12 V or 24 V respectively, the voltage shall be adjusted as declared by the manufacturer for the correct photometric functioning of that lamp.

1.1.2. Test results

1.1.2.1. Visual inspection

Once the headlamp has been stabilized to the ambient temperature, the headlamp lens and the external lens, if any, shall be cleaned with a clean, damp cotton cloth. It shall then be inspected visually; no distortion, deformation, cracking or change in colour of either the headlamp lens or the external lens, if any, shall be noticeable.

1.1.2.2. Photometric test

To comply with the requirements of this Regulation, the photometric values shall be verified in the following points:

Passing-beam:

50 R - B 50 L - HV for headlamps designed for right-hand traffic,

50 L - B 50 R - HV for headlamps designed for left-hand traffic.

Driving-beam:

Point I_{\max}

Another aiming may be carried out to allow for any deformation of the headlamp base due to heat (the change of the position of the cut-off line is covered in paragraph 2. of this annex).

A 10 per cent discrepancy between the photometric characteristics and the values measured prior to the test is permissible including the tolerances of the photometric procedure.

1.2. Dirty headlamp

After being tested as specified in paragraph 1.1. above, the headlamp shall be operated for one hour as described in paragraph 1.1.1., after being prepared as prescribed in paragraph 1.2.1., and checked as prescribed in paragraph 1.1.2.

- 1.2.1. Preparations of the headlamp
- 1.2.1.1. Test mixture
- 1.2.1.1.1. For headlamp with the outside lens in glass:
The mixture of water and a polluting agent to be applied to the headlamp shall be composed of:
9 parts by weight of silica sand with a particle size of 0-100 μm ,
1 part by weight of vegetal carbon dust (beechwood) with a particle size of 0-100 μm ,
0.2 parts by weight of NaCMC⁴, and
An appropriate quantity of distilled water, with a conductivity of ≤ 1 mS/m.
The mixture must not be more than 14 days old.
- 1.2.1.1.2. For headlamp with outside lens in plastic material:
The mixture of water and polluting agent to be applied to the headlamp shall be composed of:
9 parts by weight of silica sand with a particle size of 0-100 μm ,
1 part by weight of vegetal carbon dust (beechwood) with a particle size of 0-100 μm ,
0.2 part by weight of NaCMC⁴,
13 parts by weight of distilled water with a conductivity of ≤ 1 mS/m, and
 2 ± 1 parts by weight of surface-actant⁵
The mixture must not be more than 14 days old.
- 1.2.1.2. Application of the test mixture to the headlamp
The test mixture shall be uniformly applied to the entire light-emitting surface of the headlamp and then left to dry. This procedure shall be repeated until the illumination value has dropped to 15-20 per cent of the values measured for each following point under the conditions described in this annex:
Point of E_{max} in passing-beam/driving-beam and in driving-beam only,
50 R and 50 V⁶ for a headlamp producing only a passing-beam, designed for right-hand traffic,
50 L and 50 V⁶ for a headlamp producing only a passing-beam, designed for left-hand traffic.

⁴ NaCMC represents the sodium salt of carboxymethylcellulose, customarily referred to as CMC. The NaCMC used in the dirt mixture shall have a degree of substitution (DS) of 0.6-0.7 and a viscosity of 200-300 cP for a 2 per cent solution at 20° C.

⁵ The tolerance on quantity is due to the necessity of obtaining a dirt that correctly spreads out on all the plastic lens.

⁶ Point 50 V is situated 375 mm below HV on the vertical line v-v on the screen at 25 m distance.

2. Test for change in vertical position of the cut-off line under the influence of heat

This test consists of verifying that the vertical drift of the cut-off line under the influence of heat does not exceed a specified value for an operating headlamp producing a passing-beam.

The headlamp tested in accordance with paragraph 1., shall be subjected to the test described in paragraph 2.1., without being removed from or readjusted in relation to its test fixture.

- 2.1. Test

The test shall be carried out in a dry and still atmosphere at an ambient temperature of $23\text{ °C} \pm 5\text{ °C}$.

Using a mass production filament lamp or the LED module(s) as submitted with the headlamp, which has (have) been aged for at least one hour, the headlamp shall be operated on the principal passing-beam without being dismantled from or readjusted in relation to its test fixture. (For the purpose of this test, the voltage shall be adjusted as specified in paragraph 1.1.1.2.). The position of the cut-off line in its horizontal part (between vv and the vertical line passing through point B 50 L for right-hand traffic or B 50 R for left-hand traffic) shall be verified 3 minutes (r_3) and 60 minutes (r_{60}) respectively after operation.

The measurement of the variation in the cut-off line position as described above shall be carried out by any method giving acceptable accuracy and reproducible results.

- 2.2. Test results

- 2.2.1. The result expressed in milliradians (mrad) shall be considered as acceptable for a passing-beam headlamp when the absolute value $\Delta r_1 = |r_3 - r_{60}|$ recorded on the headlamp is not more than 1.0 mrad ($\Delta r_1 \leq 1.0\text{ mrad}$) upward and not more than 2.0 mrad ($\Delta r_1 \leq 2.0\text{ mrad}$) downwards.

- 2.2.2. However, if this value is:

<i>Movement</i>	
upward	more than 1.0 mrad but not more than 1.5 mrad ($1.0\text{ mrad} < \Delta r_1 \leq 1.5\text{ mrad}$)
downward	more than 2.0 mrad but not more than 3.0 mrad ($2.0\text{ mrad} < \Delta r_1 \leq 3.0\text{ mrad}$)

a further sample of a headlamp shall be tested as described in paragraph 2.1. after being subjected three consecutive times to the cycle as described below, in order to stabilize the position of mechanical parts of the headlamp on a base representative of the correct installation on the vehicle:

Operation of the passing-beam for one hour, (the voltage shall be adjusted as specified in paragraph 1.1.1.2.),

After this period of one hour, the headlamp type shall be considered as acceptable if the absolute value Δr measured on this sample meets the requirements in paragraph 2.2.1. above.

Annex 4 - Appendix 1

Overview of operational periods concerning test for stability of photometric performance

Abbreviations: P: passing-beam lamp
 D: driving-beam lamp (D₁ + D₂ means two driving-beams)
 F: front fog lamp
 — — — — means a cycle of 15 minutes off and 5 minutes lit
 means a cycle of 9 minutes off and 1 minute lit

All following grouped headlamps and front fog lamps together with the added marking symbols are given as examples and are not exhaustive.

1. P or D or F (HC or HR or B)

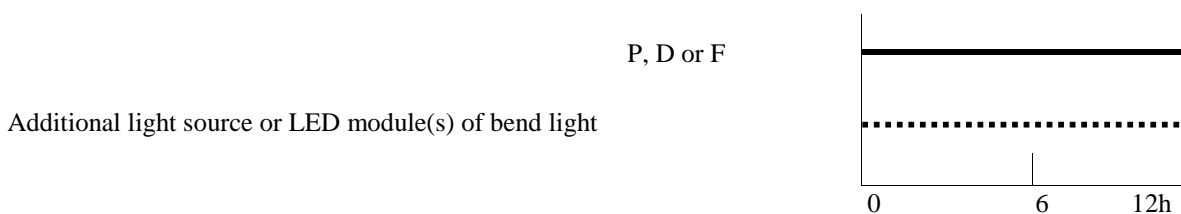

2. P+F (HC B) or P+D (HCR)

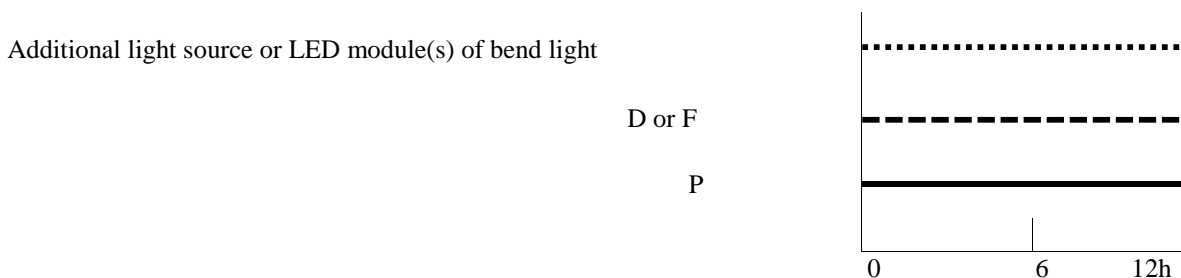

3. P+F (HC/B) or HC/B or P+D (HC/R)

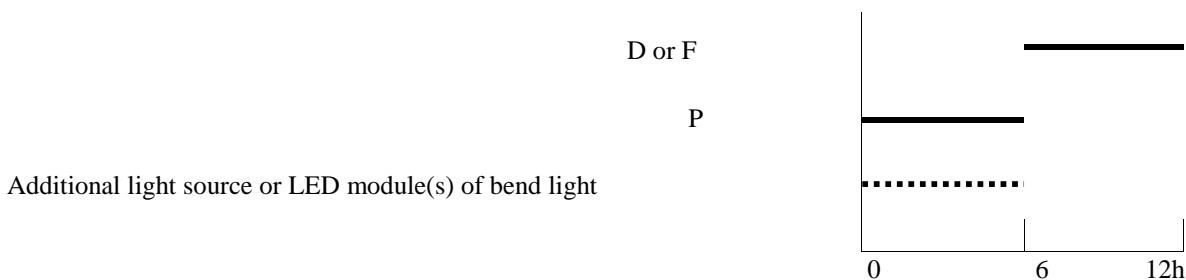

Annex 5

Minimum requirements for conformity of production control procedures

1. General
 - 1.1. The conformity requirements shall be considered satisfied from a mechanical and a geometrical standpoint, if the differences do not exceed inevitable manufacturing deviations within the requirements of this Regulation. This condition also applies to colour.
 - 1.2. With respect to photometric performances, the conformity of mass-produced headlamps shall not be contested if, when testing photometric performances of any headlamp chosen at random and equipped with a standard (étalon) filament lamp and/or LED module(s), as present in the lamp:
 - 1.2.1. No measured value deviates unfavourably by more than 20 per cent from the value prescribed in this Regulation. For values B 50 L (or R)¹ and zone III, the maximum unfavourable deviation may be respectively:

B 50 L (or R):	170 cd equivalent 20 per cent
	255 cd equivalent 30 per cent
Zone III	255 cd equivalent 20 per cent
	380 cd equivalent 30 per cent
 - 1.2.2. Or if
 - 1.2.2.1. For the passing-beam, the values prescribed in this Regulation are met at HV (with a tolerance of +170 cd) and related to that aiming at least one point within a circle of 0.35 degrees around points B 50 L (or R) (with a tolerance of 85 cd), 75 R (or L), 50 V, 25 R, 25 L, and in the entire area of zone IV which is not more than 0.52 degrees above line 25 R and 25 L;
 - 1.2.2.2. And if, for the driving-beam, HV being situated within the isolux 0.75 I_{max} a tolerance of +20 per cent for maximum values and -20 per cent for minimum values is observed for the photometric values at any measuring point specified in paragraph 6.3.2. of this Regulation.
 - 1.2.3. If the results of the test described above do not meet the requirements, the alignment of the headlamp may be changed, provided that the axis of the beam is not displaced laterally by more than 1° to the right or left.
 - 1.2.4. If in the case of a lamp equipped with a replaceable filament light source the results of the tests described above do not meet the requirements, tests shall be repeated using another standard (étalon) filament lamp.
 - 1.3. With respect to the verification of the change in vertical position of the cut-off line under the influence of heat, the following procedure shall be applied:

¹ Letters in brackets refer to headlamps intended for right-hand traffic.

One of the sampled headlamps shall be tested according to the procedure described in paragraph 2.1. of Annex 4 after being subjected three consecutive times to the cycle described in paragraph 2.2.2. of Annex 4.

The headlamp shall be considered as acceptable if Δr does not exceed 1.5 mrad.

If this value exceeds 1.5 mrad but is not more than 2.0 mrad, a second sample shall be subjected to the test after which the mean of the absolute values recorded on both samples shall not exceed 1.5 mrad.

1.4. If, however, vertical adjustment cannot be performed repeatedly to the required position within the tolerances described in paragraph 6.2.2.3. of this Regulation, one sample shall be tested according to the procedure described in paragraphs 2. and 3. of Annex 9.

2. Minimum requirements for verification of conformity by the manufacturer

For each type of headlamp the holder of the approval mark shall carry out at least the following tests, at appropriate intervals. The tests shall be carried out in accordance with the provision of this Regulation.

If any sampling shows non-conformity with regard to the type of test concerned, further samples shall be taken and tested. The manufacturer shall take steps to ensure the conformity of the production concerned.

2.1. Nature of tests

Tests of conformity in this Regulation shall cover the photometric characteristics and the verification of the change in vertical position of the cut-off line under the influence of heat.

2.2. Methods used in tests

2.2.1. Tests shall generally be carried out in accordance with the methods set out in this Regulation.

2.2.2. In any test of conformity carried out by the manufacturer, equivalent methods may be used with the consent of the competent Authority responsible for approval tests. The manufacturer is responsible for proving that the applied methods are equivalent to those laid down in this Regulation.

2.2.3. The application of paragraphs 2.2.1. and 2.2.2. requires regular calibration of test apparatus and its correlation with measurement made by a competent Authority.

2.2.4. In all cases the reference methods shall be those of this Regulation, particular for the purpose of administrative verification and sampling.

2.3. Nature of sampling

Samples of headlamps shall be selected at random from the production of a uniform batch. A uniform batch means a set of headlamps of the same type, defined according to the production methods of the manufacturer.

The assessment shall, in general, cover series production from individual factories. However, a manufacturer may group together records concerning the same type from several factories provided these operate under the same quality system and quality management.

- 2.4. Measured and recorded photometric characteristics
- The sampled headlamps shall be subjected to photometric measurements at the points provided for in the Regulation, the reading being limited at the points I_{\max} , HV², HL, HR³ in the case of a driving-beam, and to points B 50 L (or R), HV, 50 V, 75 R (or L) and 25 L (or R) in the case of the passing-beam (see figure in Annex 3).
- 2.5. Criteria governing acceptability
- The manufacturer is responsible for carrying out a statistical study of the test results and for defining, in agreement with the Competent Authority, criteria governing acceptability of his products in order to meet the specification laid down for verification of conformity of products in paragraph 10.1. of this Regulation.
- The criteria governing acceptability shall be such that, with a confidence level of 95 per cent, the minimum probability of passing a spot check in accordance with Annex 7 (first sampling) would be 0.95.

² When the driving-beam is reciprocally incorporated with the passing-beam, HV in the case of the driving-beam shall be the same measuring point as in the case of the passing-beam.

³ HL and HR: points "hh" located at 2.5 degrees to the left and to the right of point HV respectively.

Annex 6

Requirements for lamps incorporating lenses of plastic material – Testing of lens or material samples and of complete lamps

1. General specifications
 - 1.1. The samples supplied pursuant to paragraph 2.2.4. of this Regulation shall satisfy the specifications indicated in paragraphs 2.1. to 2.5. below.
 - 1.2. The two samples of complete lamps supplied pursuant to paragraph 2.2.3. of this Regulation and incorporating lenses of plastic material shall, with regard to the lens material, satisfy the specifications indicated in paragraph 2.6. below.
 - 1.3. The samples of lenses of plastic material or samples of material shall be subjected, with the reflector to which they are intended to be fitted (where applicable), to approval tests in the chronological order indicated in Table A reproduced in Appendix 1 to this annex.
 - 1.4. However, if the lamp manufacturer can prove that the product has already passed the tests prescribed in paragraphs 2.1. to 2.5. below, or the equivalent tests pursuant to another regulation, those tests need not be repeated; only the tests prescribed in Appendix 1, Table B, shall be mandatory.
2. Tests
 - 2.1. Resistance to temperature changes
 - 2.1.1. Tests

Three new samples (lenses) shall be subjected to five cycles of temperature and humidity (RH = relative humidity) change in accordance with the following programme:

 - 3 hours at $40\text{ }^{\circ}\text{C} \pm 2\text{ }^{\circ}\text{C}$ and 85-95 per cent RH;
 - 1 hour at $23\text{ }^{\circ}\text{C} \pm 5\text{ }^{\circ}\text{C}$ and 60-75 per cent RH;
 - 15 hours at $-30\text{ }^{\circ}\text{C} \pm 2\text{ }^{\circ}\text{C}$;
 - 1 hour at $23\text{ }^{\circ}\text{C} \pm 5\text{ }^{\circ}\text{C}$ and 60-75 per cent RH;
 - 3 hours at $80\text{ }^{\circ}\text{C} \pm 2\text{ }^{\circ}\text{C}$;
 - 1 hour at $23\text{ }^{\circ}\text{C} \pm 5\text{ }^{\circ}\text{C}$ and 60-75 per cent RH;

Before this test, the samples shall be kept at $23\text{ }^{\circ}\text{C} \pm 5\text{ }^{\circ}\text{C}$ and 60-75 per cent RH for at least four hours.

Note: The periods of one hour at $23\text{ }^{\circ}\text{C} \pm 5\text{ }^{\circ}\text{C}$ shall include the periods of transition from one temperature to another which are needed in order to avoid thermal shock effects.

- 2.1.2. Photometric measurements
- 2.1.2.1. Method
- Photometric measurements shall be carried out on the samples before and after the test.
- These measurements shall be made using a standard (étalon) lamp and/or LED module(s), as present in the headlamp, at the following points:
- B 50 L and 50 R for the passing-beam (B 50 R and 50 L in the case of headlamps intended for left-hand traffic);
- I_{\max} for the driving-beam.
- 2.1.2.2. Results
- The variation between the photometric values measured on each sample before and after the test shall not exceed 10 per cent including the tolerances of the photometric procedure.
- 2.2. Resistance to atmospheric and chemical agents
- 2.2.1. Resistance to atmospheric agents
- Three new samples (lenses or samples of material) shall be exposed to radiation from a source having a spectral energy distribution similar to that of a black body at a temperature between 5,500 K and 6,000 K. Appropriate filters shall be placed between the source and the samples so as to reduce as far as possible radiations with wave lengths smaller than 295 nm and greater than 2,500 nm. The samples shall be exposed to an energetic illumination of $1,200 \text{ W/m}^2 \pm 200 \text{ W/m}^2$ for a period such that the luminous energy that they receive is equal to $4,500 \text{ MJ/m}^2 \pm 200 \text{ MJ/m}^2$. Within the enclosure, the temperature measured on the black panel placed on a level with the samples shall be $50 \text{ }^\circ\text{C} \pm 5 \text{ }^\circ\text{C}$. In order to ensure a regular exposure, the samples shall revolve around the source of radiation at a speed between 1 and 5 1/min.
- The samples shall be sprayed with distilled water of conductivity lower than 1 mS/m at a temperature of $23 \text{ }^\circ\text{C} \pm 5 \text{ }^\circ\text{C}$, in accordance with the following cycle:
- spraying: 5 minutes; drying: 25 minutes.
- 2.2.2. Resistance to chemical agents
- After the test described in paragraph 2.2.1. above and the measurement described in paragraph 2.2.3.1. below have been carried out, the outer face of the said three samples shall be treated as described in paragraph 2.2.2.2. with the mixture defined in paragraph 2.2.2.1. below.
- 2.2.2.1. Test mixture
- The test mixture shall be composed of 61.5 per cent n-heptane, 12.5 per cent toluene, 7.5 per cent ethyl tetrachloride, 12.5 per cent trichloroethylene and 6 per cent xylene (volume per cent).
- 2.2.2.2. Application of the test mixture
- Soak a piece of cotton cloth (as per ISO 105) until saturation with the mixture defined in paragraph 2.2.2.1. above and, within 10 seconds, apply it for 10 minutes to the outer face of the sample at a pressure of 50 N/cm^2 , corresponding to an effort of 100 N applied on a test surface of 14 x 14 mm.

During this 10-minute period, the cloth pad shall be soaked again with the mixture so that the composition of the liquid applied is continuously identical with that of the test mixture prescribed.

During the period of application, it is permissible to compensate the pressure applied to the sample in order to prevent it from causing cracks.

2.2.2.3. Cleaning

At the end of the application of the test mixture, the samples shall be dried in the open air and then washed with the solution described in paragraph 2.3.1. (Resistance to detergents)

23 °C ± 5 °C.

Afterwards the samples shall be carefully rinsed with distilled water containing not more than 0.2 per cent impurities at 23 °C ± 5 °C and then wiped off with a soft cloth.

2.2.3. Results

2.2.3.1. After the test of resistance to atmospheric agents, the outer face of the samples shall be free from cracks, scratches, chipping and deformation, and the mean variation in transmission $\Delta t = \frac{T_2 - T_3}{T_2}$, measured on the three

samples according to the procedure described in Appendix 2 to this annex shall not exceed 0.020 ($\Delta t_m \leq 0.020$).

2.2.3.2. After the test of resistance to chemical agents, the samples shall not bear any traces of chemical staining likely to cause a variation of flux diffusion, whose mean variation $\Delta d = \frac{T_5 - T_4}{T_2}$, measured on the three samples according to

the procedure described in Appendix 2 to this annex shall not exceed 0.020 ($\Delta d_m \leq 0.020$).

2.2.4. Resistance to light source radiations

The following test shall be done:

Flat samples of each light transmitting plastic component of the headlamp are exposed to the light of the LED module(s). The parameters such as angles and distances of these samples shall be the same as in the headlamp. These samples shall have the same colour and surface treatment, if any, as the parts of the headlamp.

After 1,500 hours of continuous operation, the colorimetric specifications of the transmitted light must be met, and the surfaces of the samples shall be free of cracks, scratches, scalings or deformation.

2.3. Resistance to detergents and hydrocarbons

2.3.1. Resistance to detergents

The outer face of three samples (lenses or samples of material) shall be heated to 50 °C ± 5 °C and then immersed for five minutes in a mixture maintained at 23 °C ± 5 °C and composed of 99 parts distilled water containing not more than 0.02 per cent impurities and one part alkylaryl sulphate.

At the end of the test, the samples shall be dried at $50\text{ }^{\circ}\text{C} \pm 5\text{ }^{\circ}\text{C}$. The surface of the samples shall be cleaned with a moist cloth.

2.3.2. Resistance to hydrocarbons

The outer face of these three samples shall then be lightly rubbed for one minute with a cotton cloth soaked in a mixture composed of 70 per cent n-heptane and 30 per cent toluene (volume per cent), and shall then be dried in the open air.

2.3.3. Results

After the above two tests have been performed successively, the mean value of the variation in transmission $\Delta t = \frac{T_2 - T_3}{T_2}$, measured on the three samples

according to

The procedure described in Appendix 2 to this annex shall not exceed 0.010 ($\Delta t_m \leq 0.010$).

2.4. Resistance to mechanical deterioration

2.4.1. Mechanical deterioration method

The outer face of the three new samples (lenses) shall be subjected to the uniform mechanical deterioration test by the method described in Appendix 3 to this annex.

2.4.2. Results

After this test, the variations:

in transmission: $\Delta t = \frac{T_2 - T_3}{T_2}$,

and in diffusion: $\Delta t = \frac{T_5 - T_4}{T_2}$,

shall be measured according to the procedure described in Appendix 2 in the area specified in paragraph 2.2.4.1.1. of this Regulation. The mean value of the three samples shall be such that:

$$\Delta t_m \leq 0.100;$$

$$\Delta d_m \leq 0.050.$$

2.5. Test of adherence of coatings, if any

2.5.1. Preparation of the sample

A surface of 20 mm x 20 mm in area of the coating of a lens shall be cut with a razor blade or a needle into a grid of squares approximately 2 mm x 2 mm. The pressure on the blade or needle shall be sufficient to cut at least the coating.

2.5.2. Description of the test

Use an adhesive tape with a force adhesion of 2 N/(cm of width) ± 20 per cent measured under the standardized conditions specified in Appendix 4 to this annex. This adhesive tape, which shall be at least 25 mm wide, shall be pressed for at least five minutes to the surface prepared as prescribed in paragraph 2.5.1. above.

Then the end of the adhesive tape shall be loaded in such a way that the force of adhesion to the surface considered is balanced by a force perpendicular to that surface. At this stage, the tape shall be torn off at a constant speed of $1.5 \text{ m/s} \pm 0.2 \text{ m/s}$.

2.5.3. Results

There shall be no appreciable impairment of the gridded area. Impairments at the intersections between squares or at the edges of the cuts shall be permitted, provided that the impaired area does not exceed 15 per cent of the gridded surface.

2.6. Tests of the complete headlamp incorporating a lens of plastic material

2.6.1. Resistance to mechanical deterioration of the lens surface

2.6.1.1. Tests

The lens of lamp sample No. 1 shall be subjected to the test described in paragraph 2.4.1. above.

2.6.1.2. Results

After the test, the results of photometric measurements carried out on the headlamp in accordance with this Regulation shall not exceed by more than 30 per cent the maximum values prescribed at points B 50 L and HV and not be more than 10 per cent below the minimum values prescribed at point 75 R (in the case of headlamps intended for left-hand traffic, the points to be considered are B 50 R, HV and 75 L).

2.6.2. Test of adherence of coatings, if any

The lens of lamp sample No. 2 shall be subjected to the test described in paragraph 2.5. above.

3. Verification of the conformity of production

3.1. With regard to the materials used for the manufacture of lenses, the lamps of a series shall be recognized as complying with this Regulation if:

3.1.1. After the test for resistance to chemical agents and the test for resistance to detergents and hydrocarbons, the outer face of the samples exhibits no cracks, chipping or deformation visible to the naked eye (see paras. 2.2.2., 2.3.1. and 2.3.2. above);

- 3.1.2. After the test described in paragraph 2.6.1.1. above, the photometric values at the points of measurement considered in paragraph 2.6.1.2. above are within the limits prescribed for conformity of production by this Regulation.
- 3.2. If the test results fail to satisfy the requirements, the tests shall be repeated on another sample of headlamps selected at random.

Annex 6 - Appendix 1

Chronological order of approval tests

A. Tests on plastic materials (lenses or samples of material supplied pursuant to paragraph 2.2.4. of this Regulation).

<i>Samples</i>	<i>Lenses or samples of material</i>										<i>Lenses</i>			
	1	2	3	4	5	6	7	8	9	10	11	12	13	14
<i>Tests</i>														
1.1. Limited photometry (A.6, para. 2.1.2.)											X	X	X	
1.1.1. Temperature change (A.6, para. 2.1.1.)											X	X	X	
1.2. Limited photometry (A.6, para. 2.1.2.)											X	X	X	
1.2.1. Transmission measurement	X	X	X	X	X	X	X	X	X					
1.2.2. Diffusion measurement	X	X	X				X	X	X					
1.3. Atmospheric agents (A.6, para. 2.2.1.)	X	X	X											
1.3.1. Transmission measurement	X	X	X											
1.4. Chemical agents (A.6, para.2.2.2.)	X	X	X											
1.4.1. Diffusion measurements	X	X	X											
1.5. Detergents (A.6, para. 2.3.1.)				X	X	X								
1.6. Hydrocarbons (A.6, para. 2.3.2.)				X	X	X								
1.6.1. Transmission measurement				X	X	X								
1.7. Deterioration (A.6, para. 2.4.1.)							X	X	X					
1.7.1. Transmission measurement							X	X	X					
1.7.2. Diffusion measurement							X	X	X					
1.8. Adherence (A.6, para. 2.5.)														X
1.9 Resistance to light source radiations (A.6, para. 2.2.4.)										X				

B. Tests on complete headlamps (supplied pursuant to paragraph 2.2.3. of this Regulation).

<i>Tests</i>	<i>Complete headlamp</i>	
	<i>Sample No.</i>	
	<i>1</i>	<i>2</i>
2.1. Deterioration (para. 2.6.1.1.)	x	
2.2. Photometry (para. 2.6.1.2.)	x	
2.3. Adherence (para. 2.6.2.)		x

Annex 6 - Appendix 2

Method of measurement of the diffusion and transmission of light

1. Equipment (see figure)

The beam of a collimator K with a half divergence $\beta/2 = 17.4 \times 10^4$ rd is limited by a diaphragm D_t with an opening of 6 mm against which the sample stand is placed.

A convergent achromatic lens L_2 , corrected for spherical aberrations links the diaphragm D_t with the receiver R; the diameter of the lens L_2 shall be such that it does not diaphragm the light diffused by the sample in a cone with a half top angle of $\beta/2 = 14^\circ$.

An annular diaphragm D_D , with angles $\alpha_o/2 = 1^\circ$ and $\alpha_{max}/2 = 12^\circ$ is placed in an image focal plane of the lens L_2 .

The non-transparent central part of the diaphragm is necessary in order to eliminate the light arriving directly from the light source. It shall be possible to remove the central part of the diaphragm from the light beam in such a manner that it returns exactly to its original position.

The distance $L_2 D_t$ and the focal length F_2^1 of the lens L_2 shall be so chosen that the image of D_t completely covers the receiver R.

When the initial incident flux is referred to 1,000 units, the absolute precision of each reading shall be better than 1 unit.

2. Measurements

The following readings shall be taken:

<i>Reading</i>	<i>With sample</i>	<i>With central part of D_D</i>	<i>Quantity represented</i>
T ₁	No	No	Incident flux in initial reading
T ₂	Yes (before test)	No	Flux transmitted by the new material in a field of 24°
T ₃	Yes (after test)	No	Flux transmitted by the tested material in a field of 24°
T ₄	Yes (before test)	Yes	Flux diffused by the new material
T ₅	Yes (after test)	Yes	Flux diffused by the tested material

¹ For L_2 it is recommended to use a focal distance of about 80 mm.

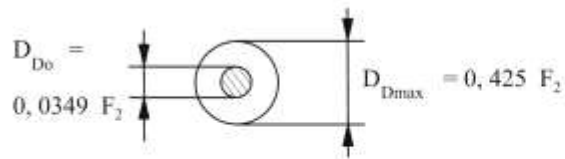
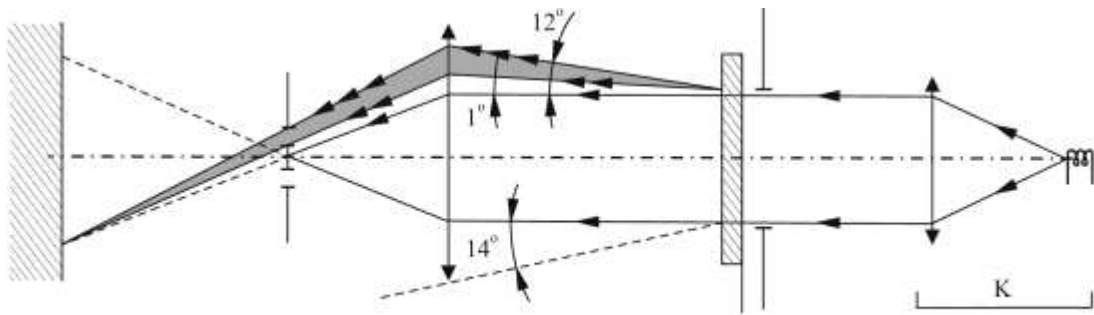

Annex 6 - Appendix 3

Spray testing method

1. Test equipment

1.1. Spray gun

The spray gun used shall be equipped with a nozzle 1.3 mm in diameter allowing a liquid flow rate of 0.24 ± 0.02 l/minute at an operating pressure of 6.0 bars $-0/+0.5$ bar.

Under these operation conditions the fan pattern obtained shall be 170 mm 50 mm in diameter on the surface exposed to deterioration, at a distance of 380 mm 10 mm from the nozzle.

1.2. Test mixture

The test mixture shall be composed of:

- (a) Silica sand of hardness 7 on the Mohr scale, with a grain size between 0 and 0.2 mm and an almost normal distribution, with an angular factor of 1.8 to 2;
- (b) Water of hardness not exceeding 205 g/m^3 for a mixture comprising 25 g of sand per litre of water.

2. Test

The outer surface of the lamp lenses shall be subjected once or more than once to the action of the sand jet produced as described above. The jet shall be sprayed almost perpendicular to the surface to be tested.

The deterioration shall be checked by means of one or more samples of glass placed as a reference near the lenses to be tested. The mixture shall be sprayed until the variation in the diffusion of light on the sample or samples measured by the method described in Appendix 2, is such that:

$$\Delta d = \frac{T_5 - T_4}{T_2} = 0.0250 \pm 0.0025$$

Several reference samples may be used to check that the whole surface to be tested has deteriorated homogeneously.

Annex 6 - Appendix 4

Adhesive tape adherence test

1. Purpose
This method allows to determine under standard conditions the linear force of adhesion of an adhesive tape to a glass plate.
2. Principle
Measurement of the force necessary to unstick an adhesive tape from a glass plate at an angle of 90°.
3. Specified atmospheric conditions
The ambient conditions shall be at $23\text{ °C} \pm 5\text{ °C}$ and 65 ± 15 per cent RH.
4. Test pieces
Before the test, the sample roll of adhesive tape shall be conditioned for 24 hours in the specified atmosphere (see para. 3 above).
Five test pieces each 400 mm long shall be tested from each roll. These test pieces shall be taken from the roll after the first three turns were discarded.
5. Procedure
The test shall be under the ambient conditions specified in paragraph 3.
Take the five test pieces while unrolling the tape radially at a speed of approximately 300 mm/s, then apply them within 15 seconds in the following manner:
Apply the tape to the glass plate progressively with a slight length-wise rubbing movement of the finger, without excessive pressure, in such a manner as to leave no air bubble between the tape and the glass plate.
Leave the assembly in the specified atmospheric conditions for 10 minutes.
Unstick about 25 mm of the test piece from the plate in a plane perpendicular to the axis of the test piece.
Fix the plate and fold back the free end of the tape at 90°. Apply force in such a manner that the separation line between the tape and the plate is perpendicular to this force and perpendicular to the plate.
Pull to unstick at a speed of $300\text{ mm/s} \pm 30\text{ mm/s}$ and record the force required.
6. Results
The five values obtained shall be arranged in order and the median value taken as a result of the measurement. This value shall be expressed in Newtons per centimetre of width of the tape.

Annex 7

Minimum requirements for sampling by an inspector

1. General
 - 1.1. The conformity requirements shall be considered satisfied from a mechanical and a geometrical standpoint in accordance with the requirements of this Regulation, if any, if the differences do not exceed inevitable manufacturing deviations. This condition also applies to colour.
 - 1.2. With respect to photometric performances, the conformity of mass-produced headlamps shall not be contested if, when testing photometric performances of any headlamp chosen at random and equipped with a standard filament lamp and/or LED module(s) present in the headlamp:
 - 1.2.1. No measured value deviates unfavourably by more than 20 per cent from the value prescribed in this Regulation. For values B 50 L (or R)¹ and zone III, the maximum unfavourable deviation may be respectively:

B 50 L (or R):	170 cd equivalent 20 per cent
	255 cd equivalent 30 per cent
Zone III	255 cd equivalent 20 per cent
	380 cd equivalent 30 per cent"
 - 1.2.2. Or if
 - 1.2.2.1. For the passing-beam, the values prescribed in this Regulation are met at HV (with a tolerance of +170 cd) and related to that aiming at least one point of each area delimited on the measuring screen (at 25 m) by a circle 15 cm in radius around points B 50 L (or R)¹ (with a tolerance of 85 cd), 75 R (or L), 50 V, 25 R, 25 L, and in the entire area of zone IV which is not more than 22.5 cm above line 25 R and 25 L;
 - 1.2.2.2. And if, for the driving-beam, HV being situated within the isolux 0.75 I_{max}, a tolerance of +20 per cent for maximum values and -20 per cent for minimum values is observed for the photometric values at any measuring point specified in paragraph 6.3.2. of this Regulation. The reference mark is disregarded.
 - 1.2.3. If the results of the test described above do not meet the requirements, the alignment of the headlamp may be changed, provided that the axis of the beam is not displaced laterally by more than 1° to the right or left.

¹ Letters in brackets refer to headlamps intended for right-hand traffic.

- 1.2.4. If the results of the tests described above do not meet the requirements, tests shall be repeated using another standard filament lamp and/or LED module(s) present in the headlamp.
- 1.2.5. Headlamps with apparent defects are disregarded.
- 1.2.6. The reference mark is disregarded.
- 1.3. If, however, vertical adjustment cannot be performed repeatedly to the required position within the tolerances described in paragraph 6.2.2.3. of this Regulation, one sample shall be tested according to the procedure described in paragraphs 2. and 3. of Annex 9.
2. First sampling
- In the first sampling four headlamps are selected at random. The first sample of two is marked A, the second sample of two is marked B.
- 2.1. The conformity is not contested
- 2.1.1. Following the sampling procedure shown in Figure 1 of this annex the conformity of mass-produced headlamps shall not be contested if the deviations of the measured values of the headlamps in the unfavourable directions are:
- 2.1.1.1. Sample A
- | | | | |
|-----|----------------|---------------|-------------|
| A1: | one headlamp | | 0 per cent |
| | one headlamp | not more than | 20 per cent |
| A2: | both headlamps | more than | 0 per cent |
| | but | not more than | 20 per cent |
| | go to sample B | | |
- 2.1.1.2. Sample B
- | | | | |
|-----|----------------|--|------------|
| B1: | both headlamps | | 0 per cent |
|-----|----------------|--|------------|
- 2.1.2. Or if the conditions of paragraph 1.2.2. for sample A are fulfilled.
- 2.2. The conformity is contested
- 2.2.1. Following the sampling procedure shown in Figure 1 of this annex the conformity of mass-produced headlamps shall be contested and the manufacturer requested to make his production meet the requirements (alignment) if the deviations of the measured values of the headlamps are:
- 2.2.1.1. Sample A
- | | | | |
|-----|--------------|---------------|-------------|
| A3: | one headlamp | not more than | 20 per cent |
| | one headlamp | more than | 20 per cent |
| | but | not more than | 30 per cent |
- 2.2.1.2. Sample B
- | | | | |
|-----|-------------------|---------------|-------------|
| B2: | in the case of A2 | | |
| | one headlamp | more than | 0 per cent |
| | but | not more than | 20 per cent |
| | one headlamp | not more than | 20 per cent |

- B3: in the case of A2
- | | | |
|--------------|---------------|-------------|
| one headlamp | | 0 per cent |
| one headlamp | more than | 20 per cent |
| but | not more than | 30 per cent |
- 2.2.2. Or if the conditions of paragraph 1.2.2. for sample A are not fulfilled.
- 2.3. Approval withdrawn
- Conformity shall be contested and paragraph 11. applied if, following the sampling procedure shown in Figure 1 of this annex, the deviations of the measured values of the headlamps are:
- 2.3.1. Sample A
- | | | |
|--------------------|---------------|-------------|
| A4: one headlamp | not more than | 20 per cent |
| one headlamp | more than | 30 per cent |
| A5: both headlamps | more than | 20 per cent |
- 2.3.2. Sample B
- B4: in the case of A2
- | | | |
|--------------|---------------|-------------|
| one headlamp | more than | 0 per cent |
| but | not more than | 20 per cent |
| one headlamp | more than | 20 per cent |
- B5: in the case of A2
- | | | |
|----------------|-----------|-------------|
| both headlamps | more than | 20 per cent |
|----------------|-----------|-------------|
- B6: in the case of A2
- | | | |
|--------------|-----------|-------------|
| one headlamp | | 0 per cent |
| one headlamp | more than | 30 per cent |
- 2.3.3. Or if the conditions of paragraph 1.2.2. for samples A and B are not fulfilled.
3. Repeated sampling
- In the case of A3, B2, B3 a repeated sampling, third sample C of two headlamps, selected from stock manufactured after alignment, is necessary within two months' time after the notification.
- 3.1. The conformity is not contested
- 3.1.1. Following the sampling procedure shown in Figure 1 of this annex the conformity of mass-produced headlamps shall not be contested if the deviations of the measured values of the headlamps are:
- 3.1.1.1. Sample C
- | | | |
|--------------------|---------------|-------------|
| C1: one headlamp | | 0 per cent |
| one headlamp | not more than | 20 per cent |
| C2: both headlamps | more than | 0 per cent |
| but | not more than | 20 per cent |
- go to sample D

- 3.1.1.2. Sample D
- D1: in the case of C2
both headlamps 0 per cent
- 3.1.2. Or if the conditions of paragraph 1.2.2. for sample C are fulfilled.
- 3.2. The conformity is contested
- 3.2.1. Following the sampling procedure shown in Figure 1 of this annex the conformity of mass-produced headlamps shall be contested and the manufacturer requested to make his production meet the requirements (alignment) if the deviations of the measured values of the headlamps are:
- 3.2.1.1. Sample D
- D2: in the case of C2
- | | | |
|--------------|---------------|-------------|
| one headlamp | more than | 0 per cent |
| but | not more than | 20 per cent |
| one headlamp | not more than | 20 per cent |
- 3.2.1.2. Or if the conditions of paragraph 1.2.2. for sample C are not fulfilled.
- 3.3. Approval withdrawn
- Conformity shall be contested and paragraph 11. applied if, following the sampling procedure shown in Figure 1 of this annex, the deviations of the measured values of the headlamps are:
- 3.3.1. Sample C
- | | | |
|--------------------|---------------|-------------|
| C3: one headlamp | not more than | 20 per cent |
| one headlamp | more than | 20 per cent |
| C4: both headlamps | more than | 20 per cent |
- 3.3.2. Sample D
- D3: in the case of C2
- | | | |
|--------------|----------------|-------------|
| one headlamp | 0 or more than | 0 per cent |
| one headlamp | more than | 20 per cent |
- 3.3.3. Or if the conditions of paragraph 1.2.2. for samples C and D are not fulfilled.
4. Change of the vertical position of the cut-off line
- With respect to the verification of the change in vertical position of the cut-off line under the influence of heat, the following procedure shall be applied:
- One of the headlamps of sample A after sampling procedure in Figure 1 of this annex shall be tested according to the procedure described in paragraph 2.1. of Annex 4 after being subjected three consecutive times to the cycle described in paragraph 2.2.2. of Annex 4.
- The headlamp shall be considered as acceptable if Δr does not exceed 1.5 mrad.

If this value exceeds 1.5 mrad but is not more than 2.0 mrad, the second headlamp of sample A shall be subjected to the test after which the mean of the absolute values recorded on both samples shall not exceed 1.5 mrad.

However, if this value of 1.5 mrad on sample A is not complied with, the two headlamps of sample B shall be subjected to the same procedure and the value of Δr for each of them shall not exceed 1.5 mrad.

Figure 1

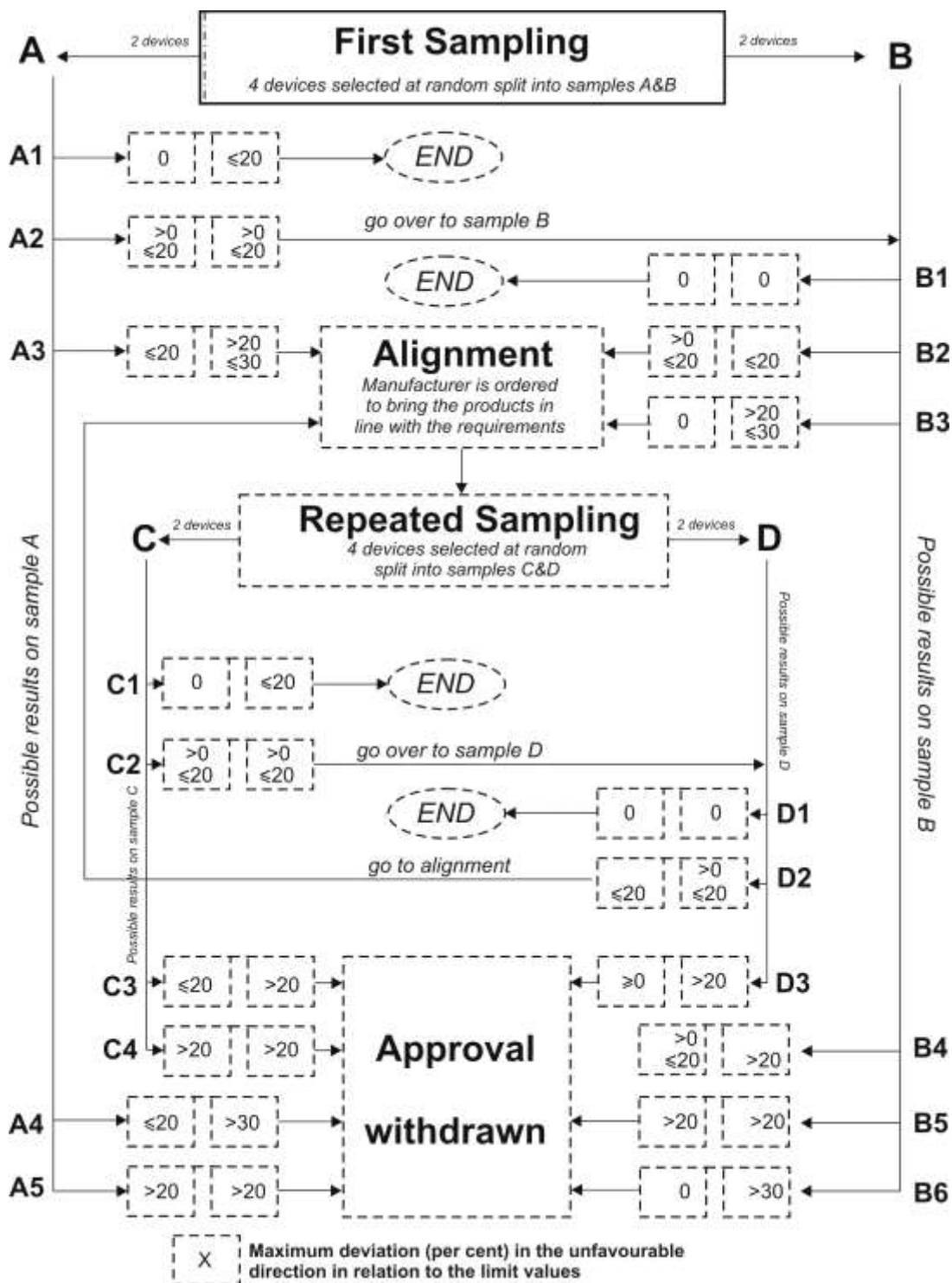

Annex 8

Overview of operational periods concerning tests for stability of photometric performance

- Abbreviations: P: passing-beam lamp
 D: driving-beam lamp ($D_1 + D_2$ means two driving-beams)
 F: front fog lamp
 - - - - -: means a cycle of 15 minutes off and 5 minutes lit.

All following grouped headlamps and front fog lamps together with the added class B marking symbols are given as examples and are not exhaustive.

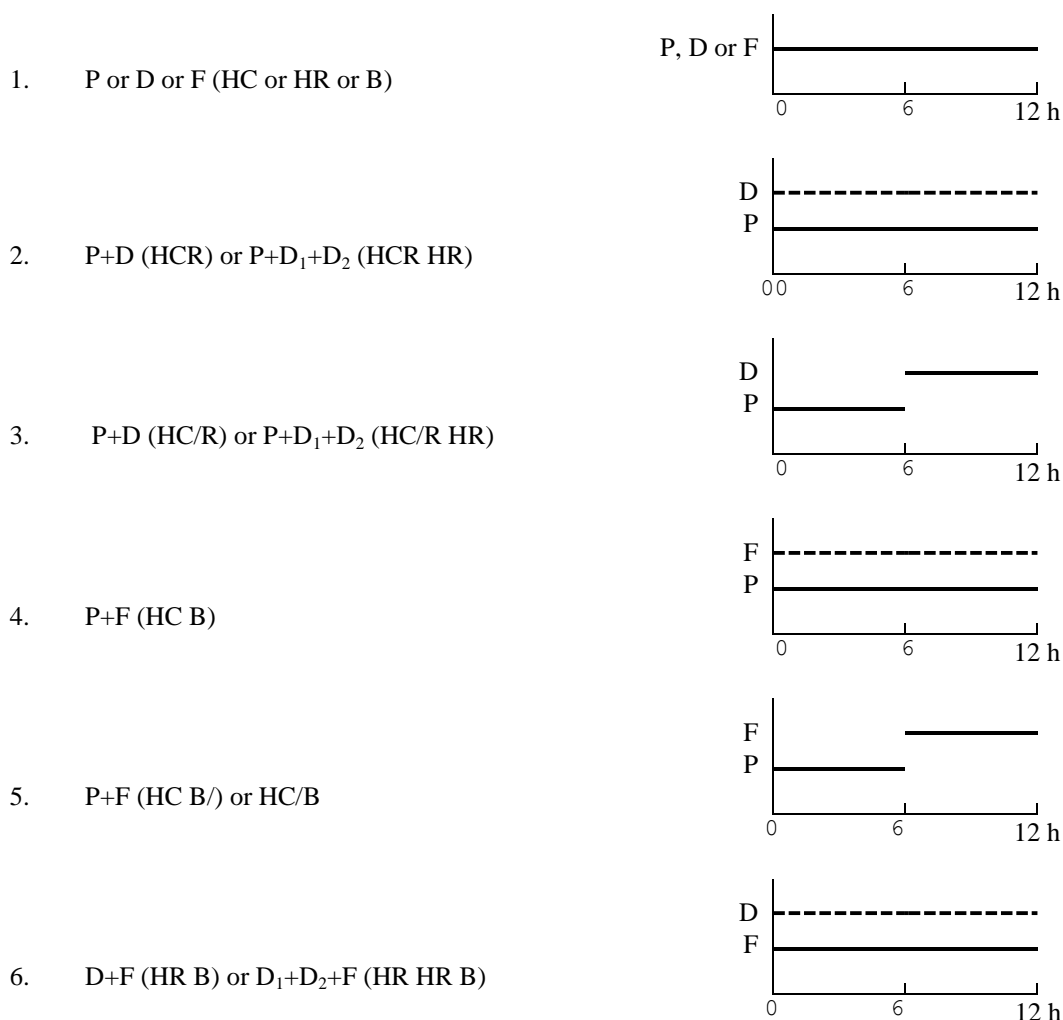

7. D+F (HR B/) or D_1+D_2+F (HR HR B/)

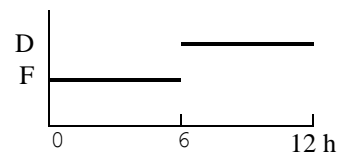

8. P+D+F (HCR B) or $P+D_1+D_2+F$ (HCR HR B)

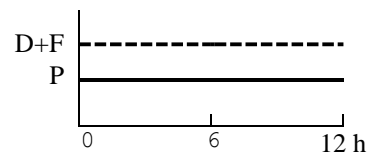

9. P+D+F (HC/R B) or $P+D_1+D_2+F$ (HC/R HR B)

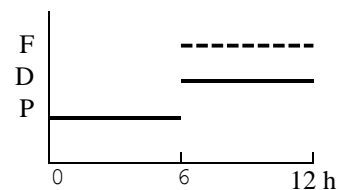

10. P+D+F (HCR B/) or $P+D_1+D_2+F$ (HCR HR B/)

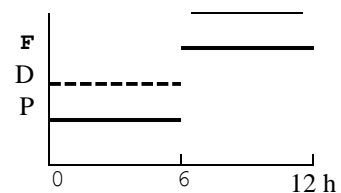

11. P+D+F (HC/R B/) or $P+D_1+D_2+F$ (HC/R HR B/)

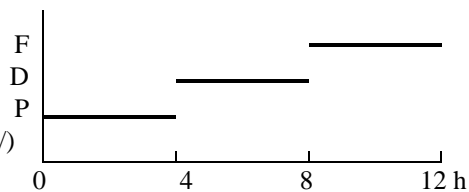

Annex 9

Instrumental verification of the "cut-off" for passing-beam headlamps

1. General

In the case where paragraph 6.2.2.4. of this Regulation applies, the quality of the "cut-off" shall be tested according to the requirements set out in paragraph 2. below and the instrumental vertical and horizontal adjustment of the beam shall be performed according to the requirements set out in paragraph 3. below.

Before carrying out the measurement of the quality of "cut-off" and the instrumental aiming procedure, a visual pre-aim in accordance with paragraphs 6.2.2.1. and 6.2.2.2. of this Regulation is required.

2. Measurement of the quality of the "cut-off"

To determine the minimum sharpness, measurements shall be performed by vertically scanning through the horizontal part of the "cut-off" in angular steps of 0.05° at either a measurement distance of:

- (a) 10 m with a detector having a diameter of approximately 10 mm or
- (b) 25 m with a detector having a diameter of approximately 30 mm.

The measuring distance at which the test was carried out shall be recorded in item 9. of the communication form (see Annex 1 of this Regulation).

To determine the maximum sharpness, measurements shall be performed by vertically scanning through the horizontal part of the "cut-off" in angular steps of 0.05° exclusively at a measurement distance of 25 m and with a detector having a diameter of approximately 30 mm.

The "cut-off" quality shall be considered acceptable if the requirements of paragraphs 2.1. to 2.3. below comply with at least one set of measurements.

2.1. Not more than one "cut-off" shall be visible¹.

2.2. Sharpness of "cut-off"

The sharpness factor G is determined by scanning vertically through the horizontal part of the "cut-off" at 2.5° from the V-V where:

$G = (\log E_\beta - \log E_{(\beta+0.1^\circ)})$ where β = the vertical position in degrees.

The value of G shall not be less than 0.13 (minimum sharpness) and not greater than 0.40 (maximum sharpness).

2.3. Linearity

The part of the horizontal "cut-off" that serves for vertical adjustment shall be horizontal between 1.5° and 3.5° from the V-V line (see Figure 1).

¹ This paragraph should be amended when an objective test method is available.

The inflection points of the "cut-off" gradient at the vertical lines at 1.5°, 2.5° and 3.5° shall be determined by the equation:

The maximum vertical distance between the inflection points determined shall not exceed 0.2°.

$$(d^2 (\log E) / d\beta^2 = 0).$$

3. Vertical and horizontal adjustment

If the "cut-off" complies with the quality requirements of paragraph 2. of this annex, the beam adjustment may be performed instrumentally.

Figure 1
 Measurement of "cut-off" quality

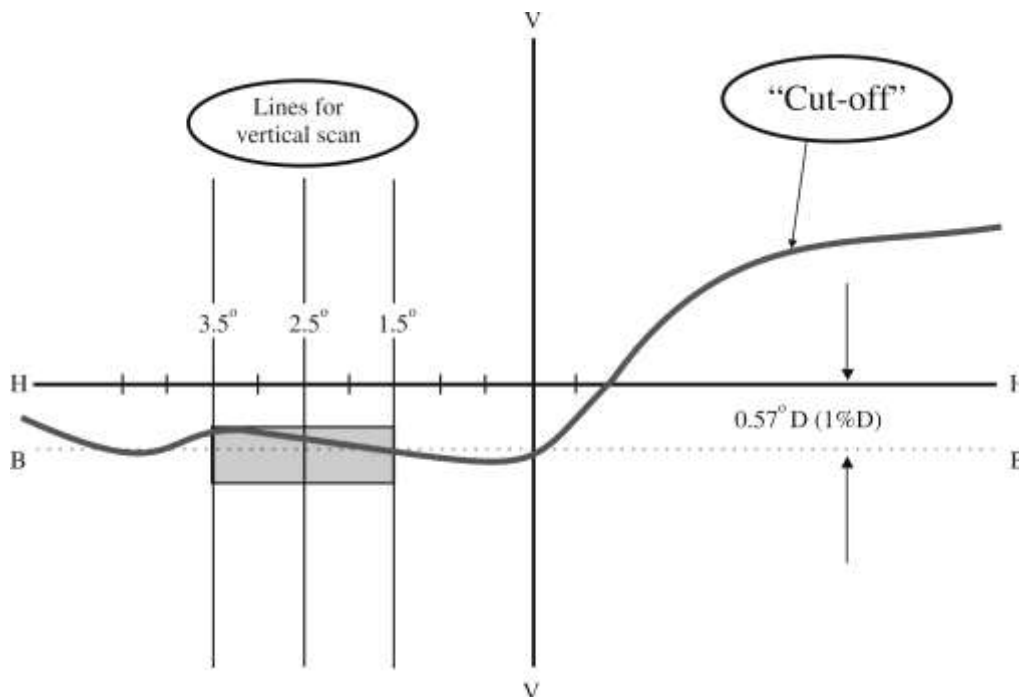

Note: The scales are different for vertical and horizontal lines.

3.1. Vertical adjustment

Moving upward from below the line B (see Figure 2 below), a vertical scan is carried out through the horizontal part of the "cut-off" at 2.5° from V-V. The inflection point (where $d^2 (\log E) / dv^2 = 0$) is determined and positioned on the line B situated one per cent below H-H.

3.2. Horizontal adjustment

The applicant shall specify one of the following horizontal aim methods:

- (a) The "0.2 D line" method (see Figure 2 below).

A single horizontal line at 0.2° D shall be scanned from 5° left to 5° right after the lamp has been aimed vertically. The maximum gradient "G" determined using the formula $G = (\log E_{\beta} - \log E_{(\beta + 0.1^{\circ})})$ where β is the horizontal position in degrees, shall not be less than 0.08.

The inflection point found on the 0.2 D line shall be positioned on the line A.

Figure 2

Instrumental vertical and horizontal adjustment - horizontal line scan method

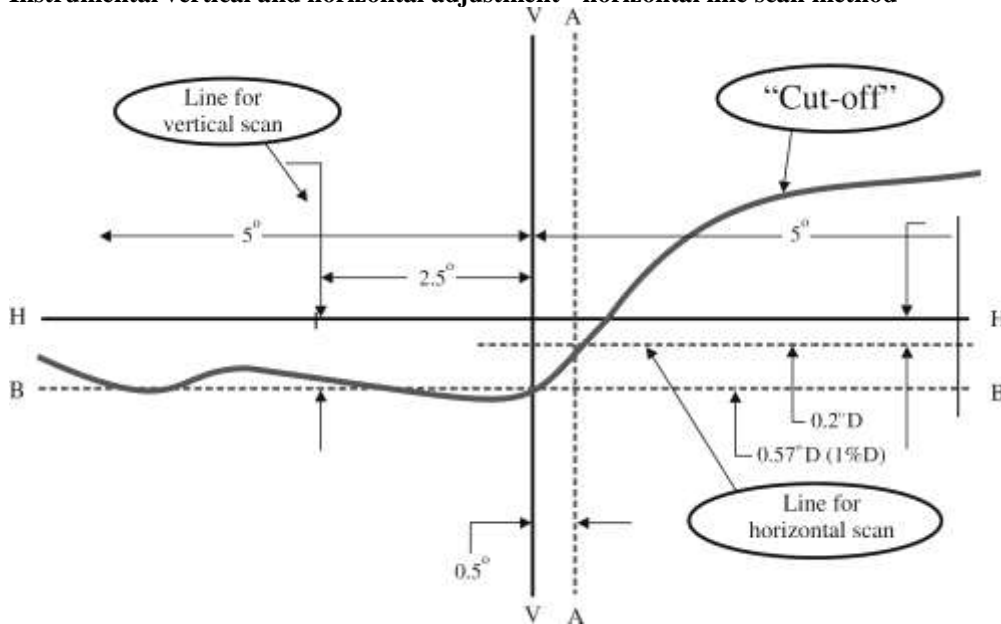

Note: The scales are different for vertical and horizontal lines.

- (b) The "3 line" method (see Figure 3)

Three vertical lines shall be scanned from 2° D to 2° U at 1°R, 2°R, and 3°R after the lamp has been aimed vertically. The respective maximum gradients "G" determined using the formula:

$$G = (\log E_{\beta} - \log E_{(\beta + 0.1^\circ)})$$

where β is the vertical position in degrees, shall not be less than 0.08. The inflection points found on the three lines shall be used to derive a straight line. The intersection of this line and the line B found while performing vertical aim shall be placed on the V line.

Figure 3
Instrumental vertical and horizontal adjustment - Three line scan method

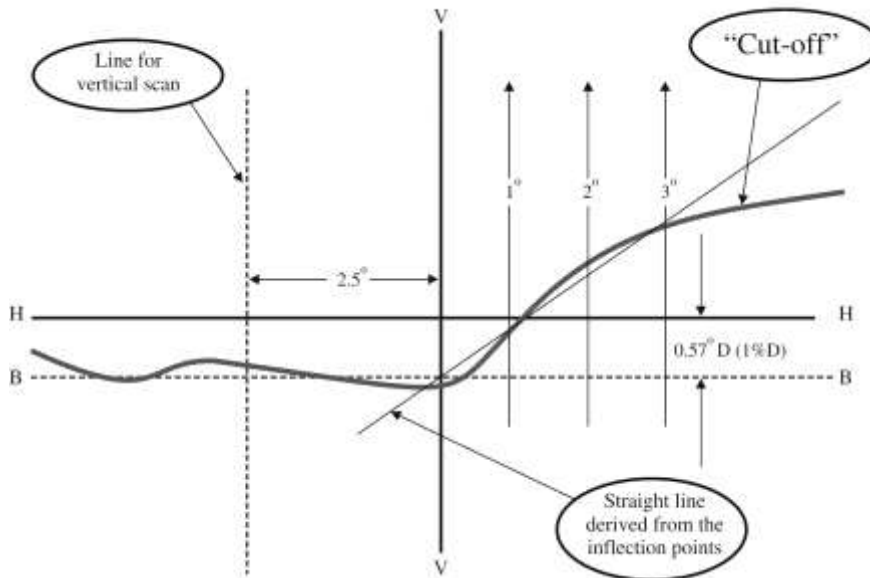

Note: The scales are different for vertical and horizontal lines.

Annex 10

Requirements for LED modules and headlamps including LED modules

1. General specifications
 - 1.1. Each LED module sample submitted shall conform to the relevant specifications of this Regulation when tested with the supplied electronic light source control-gear(s), if any.
 - 1.2. LED module(s) shall be so designed as to be and to remain in good working order when in normal use. They shall moreover exhibit no fault in design or manufacture. A LED module shall be considered to have failed if any one of its LEDs has failed.
 - 1.3. LED module(s) shall be tamperproof.
 - 1.4. The design of removable LED module(s) shall be such that:
 - 1.4.1. When the LED module is removed and replaced by another module provided by the applicant and bearing the same light source module identification code, the photometric specifications of the headlamp shall be met;
 - 1.4.2. LED modules with different light source module identification codes within the same lamp housing, shall not be interchangeable.
2. Manufacture
 - 2.1. The LED(s) on the LED module shall be equipped with suitable fixation elements.
 - 2.2. The fixation elements shall be strong and firmly secured to the LED(s) and the LED module.
3. Test conditions
 - 3.1. Application
 - 3.1.1. All samples shall be tested as specified in paragraph 4. below.
 - 3.1.2. The kind of light sources on a LED module shall be light-emitting diodes (LED) as defined in Regulation No. 48 paragraph 2.7.1. in particular with regard to the element of visible radiation. Other kinds of light sources are not permitted.
 - 3.2. Operating conditions
 - 3.2.1. LED module operating conditions

All samples shall be tested under the conditions as specified in paragraphs 6.1.4. and 6.1.5. of this Regulation. If not specified differently in this annex LED modules shall be tested inside the headlamp as submitted by the manufacturer.

3.2.2. Ambient temperature

For the measurement of electrical and photometric characteristics, the headlamp shall be operated in a dry and still atmosphere at an ambient temperature of $23\text{ }^{\circ}\text{C} \pm 5\text{ }^{\circ}\text{C}$.

3.3. Ageing

Upon the request of the applicant the LED module shall be operated for 15 h and cooled down to ambient temperature before starting the tests as specified in this Regulation.

4. Specific requirements and tests

4.1. Colour rendering

4.1.1. Red content

In addition to measurements as described in paragraph 7. of this Regulation:

The minimum red content of the light of a LED module or headlamp incorporating LED module(s) tested at 50 V shall be such that:

$$k_{\text{red}} = \frac{\int_{\lambda=610\text{nm}}^{780\text{nm}} E_e(\lambda) V(\lambda) d\lambda}{\int_{\lambda=380\text{nm}}^{780\text{nm}} E_e(\lambda) V(\lambda) d\lambda} \geq 0.05$$

where:

$E_e(\lambda)$ (unit: W) is the spectral distribution of the irradiance;

$V(\lambda)$ (unit: 1) is the spectral luminous efficiency;

(λ) (unit: nm) is the wavelength.

This value shall be calculated using intervals of one nanometre.

4.2. UV-radiation

The UV-radiation of a low-UV-type LED module shall be such that:

$$k_{\text{UV}} = \frac{\int_{\lambda=250\text{nm}}^{400\text{nm}} E_e(\lambda) S(\lambda) d\lambda}{k_m \int_{\lambda=380\text{nm}}^{780\text{nm}} E_e(\lambda) V(\lambda) d\lambda} \leq 10^{-5} \text{ W / lm}$$

where:

$S(\lambda)$ (unit: 1) is the spectral weighting function;

$k_m = 683 \text{ lm/W}$ is the maximum value of the luminous efficacy of radiation.

(For definitions of the other symbols see paragraph 4.1.1. above).

This value shall be calculated using intervals of one nanometre. The UV-radiation shall be weighted according to the values as indicated in the Table UV below:

Table UV
Values according to "IRPA/INIRC Guidelines on limits of exposure to ultraviolet radiation".
Wavelengths (in nanometres) chosen are representative; other values should be interpolated.

λ	$S(\lambda)$	λ	$S(\lambda)$	λ	$S(\lambda)$
250	0.430	305	0.060	355	0.000 16
255	0.520	310	0.015	360	0.000 13
260	0.650	315	0.003	365	0.000 11
265	0.810	320	0.001	370	0.000 09
270	1.000	325	0.000 50	375	0.000 077
275	0.960	330	0.000 41	380	0.000 064
280	0.880	335	0.000 34	385	0.000 053
285	0.770	340	0.000 28	390	0.000 044
290	0.640	345	0.000 24	395	0.000 036
295	0.540	350	0.000 20	400	0.000 030
300	0.300				

4.3. Temperature stability

4.3.1. Illuminance

4.3.1.1. A photometric measurement of the headlamp shall be made after 1 minute of operation for the specific function at the test point specified below. For these measurements, the aim can be approximate but must be maintained for before and after ratio measurements.

Test points to be measured:

Passing-beam 50 V

Driving-beam H – V

4.3.1.2. The lamp shall continue operation until photometric stability has occurred. The moment at which the photometry is stable is defined as the point in time at which the variation of the photometric value is less than 3 per cent within any 15 minutes period. After stability has occurred, aim for complete photometry shall be performed in accordance with the requirements of the specific device. Photometer the lamp at all test points required for the specific device.

4.3.1.3. Calculate the ratio between the photometric test point value determined in paragraph 4.3.1.1. above and the point value determined in paragraph 4.3.1.2. above.

4.3.1.4. Once stability of photometry has been achieved, apply the ratio calculated above to each of the remainder of the test points to create a new photometric table that describes the complete photometry based on one minute of operation.

4.3.1.5. The luminous intensity values, measured after one minute and after photometric stability has occurred, shall comply with the minimum and maximum requirements.

4.3.2. Colour

The colour of the light emitted measured after one minute and measured after photometric stability has been obtained, as described in paragraph 4.3.1.2. of this annex, shall both be within the required colour boundaries.

5. The measurement of the objective luminous flux of LED module(s) producing the principal passing-beam shall be carried out as follows:

5.1. The LED module(s) shall be in the configuration as described in the technical specification as defined in paragraph 2.2.2. of this Regulation. Optical elements (secondary optics) shall be removed by the Technical Service at the request of the applicant by the use of tools. This procedure and the conditions during the measurements as described below shall be described in the test report.

5.2. Three LED modules of each type shall be submitted by the applicant with the light source control gear, if applicable, and sufficient instructions.

Suitable thermal management (e.g. heat sink) may be provided, to simulate similar thermal conditions as in the corresponding headlamp application.

Before the test each LED module shall be aged at least for seventy-two hours under the same conditions as in the corresponding headlamp application.

In the case of use of an integrating sphere, the sphere shall have a minimum diameter of one meter, and at least ten times the maximum dimension of the LED module, whichever is the largest. The flux measurements can also be performed by integration using a goniophotometer. The prescriptions in CIE - Publication 84 - 1989, regarding the room temperature, positioning, etc., shall be taken into consideration.

The LED module shall be burned in for approximately one hour in the closed sphere or goniophotometer.

The flux shall be measured after stability has occurred, as explained in paragraph 4.3.1.2. of this annex to this Regulation.

The average of the measurements of the three samples of each type of LED module shall be deemed to be its objective luminous flux.

Annex 11

A general illustration for principal passing-beam and beam contributors and correlated light source options

